

Anritsu Advancing beyond

Signal Integrity Analysis Multi-channel High-Performance BERT

Signal Quality Analyzer-R
MP1900A Series

 **SQA-R**

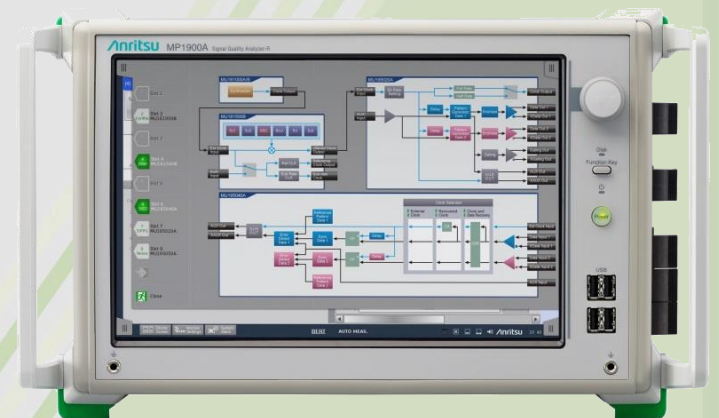

- Due to the explosive growth of data traffic resulting from the popularity of smartphones and mobile terminals, data centers are transitioning network interfaces to faster 200/400/800 GbE standards, and PCI bus interconnects speeds now exceed 10G. In addition, support for multi-channels is also increasing transitioning.
- The Signal Quality Analyzer-R MP1900A series is an 8-slot modular type, high-performance BERT with excellent expandability supporting measurement applications by installing 32 Gbit/s Multi-channel PPG/ED, 64 Gbaud PAM4 PPG/ED and Jitter/Noise addition modules for signal integrity analysis of increasingly faster devices. Moreover, as well as functions for evaluating the Physical layer of high-speed interfaces, the built in Link Training/LTSSM analysis function supports all in one measurement of high-speed network interfaces such as 400/800 GbE, and bus interfaces such as PCIe.

MP1900A Series Supported Applications

100 GbE/200 GbE/400 GbE/800 GbE, CEI-25G/28G/56G/112G,

InfiniBand EDR/HDR/NDR, Fibre Channel

PCI Express Gen1 to 6, USB 3.2/USB4, Thunderbolt 3, SAS-3/SAS-4, DP1.4

Optical Module, SERDES, AOC, High-Speed Interconnect

MP1900A Update Points [1]

The MP1900A series is a high-expandability, high-performance BERT supporting physical layer evaluations of high-speed interfaces. The all-in-one design covers early stage R&D evaluations ranging from next-generation 400/800 GbE network interfaces to PCI Express, etc., bus interfaces.

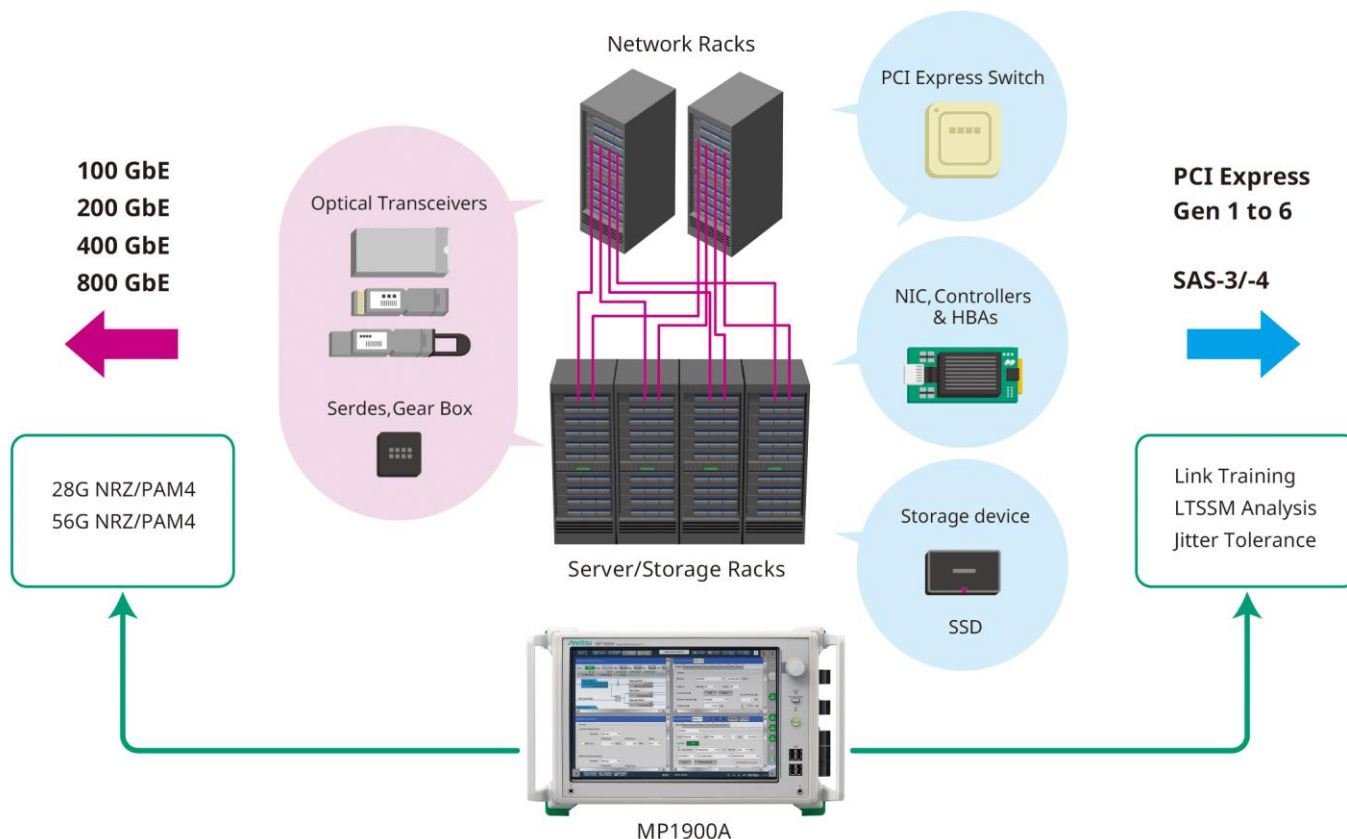

MP1900A Update Points [2]

With the increase in various serial-bus interface speeds linking PCs and peripherals, quality can only be assured by accurate Physical layer evaluations. The MP1900A with integrated application software controls peripheral equipment to accurately and quickly perform the measurements required by each standard.

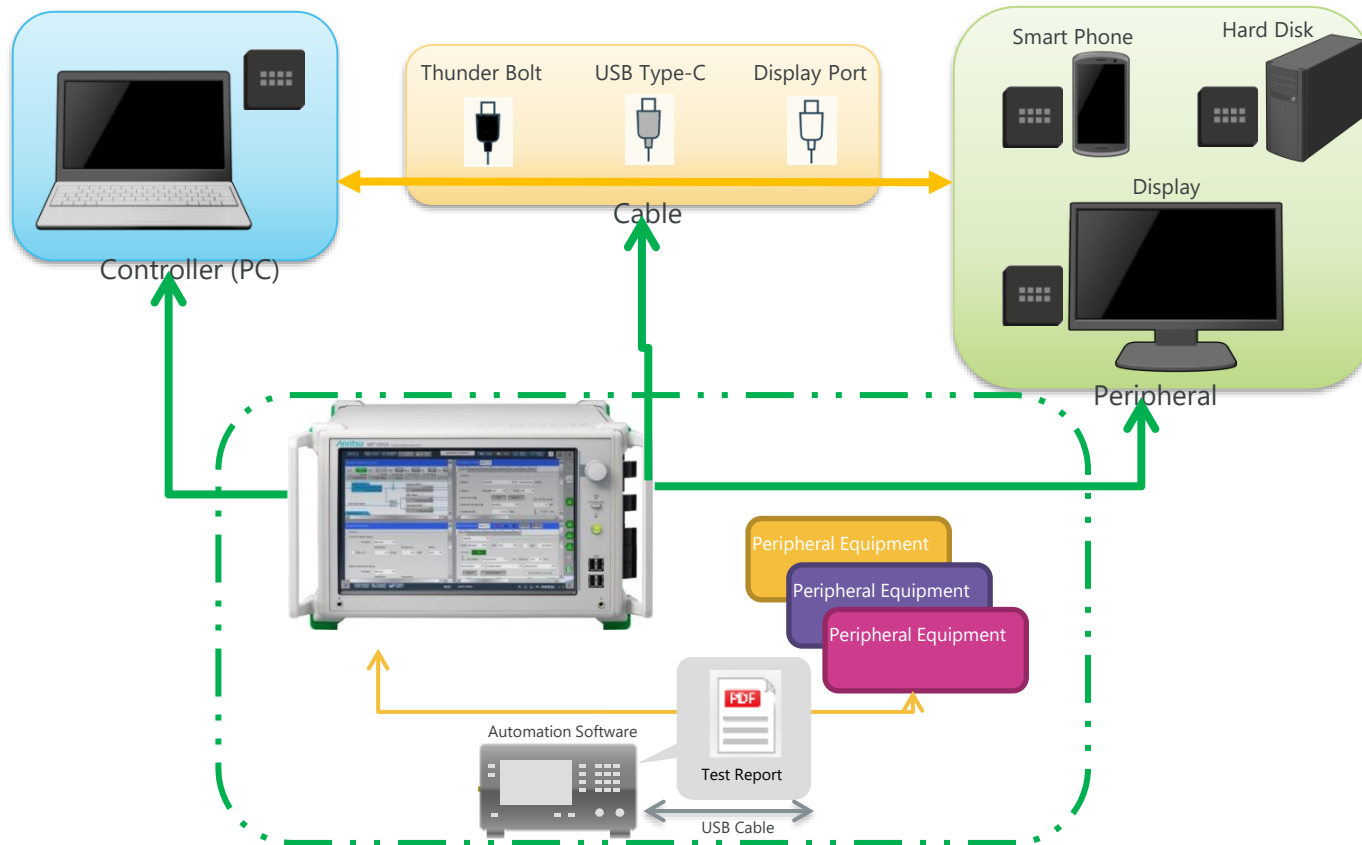

Multi-IF Support

Supports IF speeds over wide bandwidth from 2.4 Gbit/s to 21 Gbit/s with expandability to 32 Gbit/s without hardware upgrades; one unit enables Rx tests for PCIe Gen5 (32 GT/s), USB Type-C (USB4 (20 Gbit/s) , Thunderbolt3 (20 Gbit/s)) , DisplayPort1.4 (8.1 Gbit/s) and SAS-4 (22.5 Gbit/s).

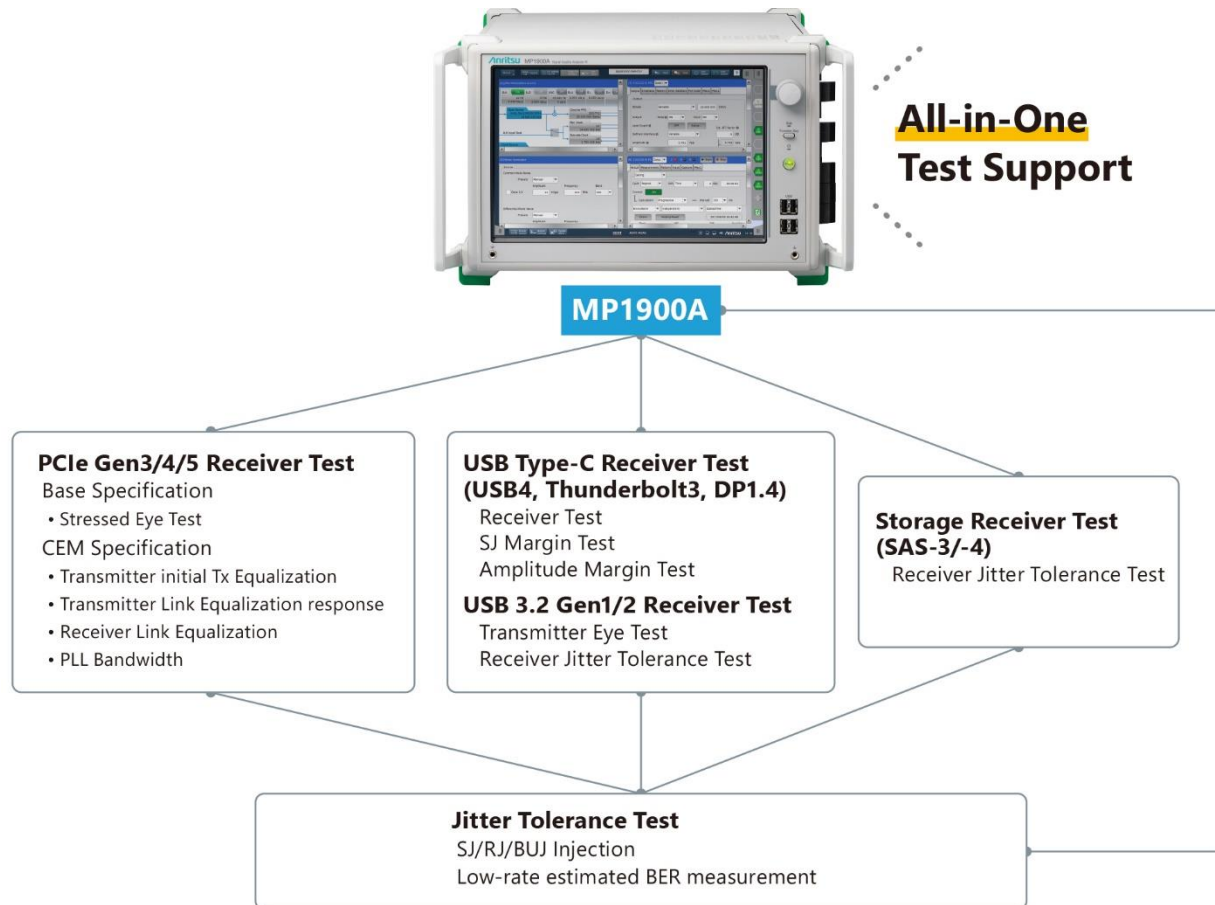

Excellent expandability

- 8 slots (per one MP1900A main unit)
- Maximum transmission capacity up to 512 Gbit/s (supporting up to 16ch of 32 Gbit/s NRZ, 4ch of 64 Gbaud PAM4)
- All-in-one support for both high-speed network interfaces such as 400/800 GbE and bus interfaces such as PCIe

Full support for high-speed device signal integrity evaluations

- Bit rates of 2.4 Gbit/s to 32.1 Gbit/s (NRZ, SI PPG/ED series)
2.4 Gbaud to 64.2 Gbaud (128.4 Gbit/s) (PAM4, PAM4 PPG/ED series)
- Built-in Emphasis and Equalizer
- Low Intrinsic Jitter data output 115 fs rms (typ., SI PPG)
- High input sensitivity 15 mV (Eye Height) (typ., SI PPG)
- Built-in Clock Recovery
- Jitter (SJ/RJ/BUJ/SSC) and noise (CM/DM/White) tolerance measurements

All-in-one coverage of next-generation digital interface Rx tests

- Supports PCIe Gen1 to Gen5, SAS-3/-4, USB Type-C interface (USB3.2/USB4/Thunderbolt3), and DisplayPort1.4.
- Link Negotiation and LTSSM analysis functions
- Automated test-signal calibration and receiver tests

Supports Wideband & Multi-channel Measurement Requirements

The 8-slot modular type Signal Quality Analyzer-R MP1900A can be easily customized to support more measurement channels and new required functions and performance without wasting previous investments in equipment. With cost-effective upgrade support for next-generation interfaces, such as 400/800 GbE, the MP1900A will play a key role in bringing customers' products more quickly to market .

SI PPG/ED Module Expandability

- NRZ (Max. 32 Gbit/s at 1ch)

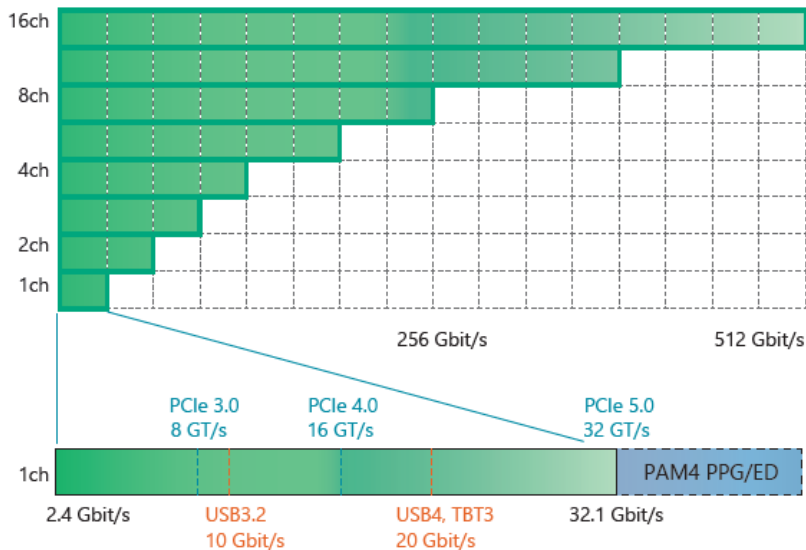

PAM4 PPG/ED Expandability*

- NRZ (Max. 64 Gbit/s at 1ch)

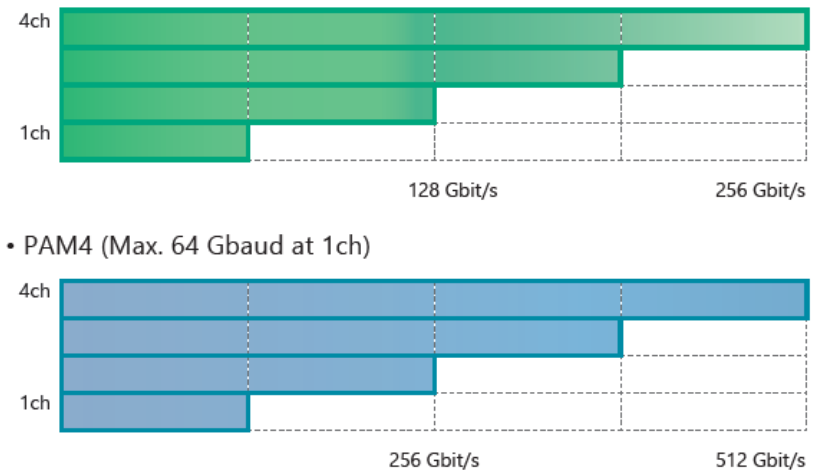

- PAM4 (Max. 64 Gbaud at 1ch)

*: Refer to the 32G/64G NRZ/PAM4 Signal Integrity Test Solution Catalog (MP1900A_64G-E-A-1) for details of PAM4 PPG/ED.

Ideal for Signal Integrity Evaluations (1/2)

The 21G/32G bit/s SI PPG MU195020A has a built in 10Tap (max.) Emphasis option for simulating various devices and channels as well as for outputting corrected waveforms reproducing channel-path losses to help improve design evaluation efficiency.

The Rx-side 21G/32G bit/s SI ED MU195040A has a built in multi-band CTLE (Continuous Time Linear Equalization) function supporting 28, 16, and 8 Gbit/s band input signals for performing BER measurements of Eyes closed by transmission path losses. Since this CTLE function is a hardware equalizer rather than software emulator, it supports evaluation of TRx BER performance under near-to-live conditions, such as BER evaluation of test signals, and comparison of DUT BER measurement results.

Signal Integrity Evaluations Required Performance and Functions

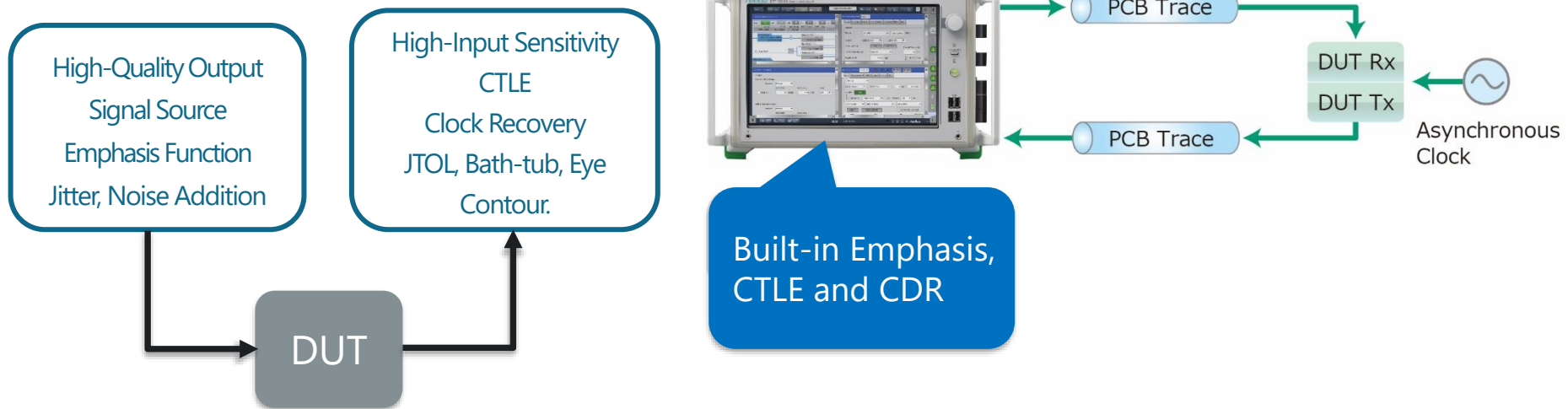

Ideal for Signal Integrity Evaluations (2/2)

To perform high-speed receiver stressed input tolerance tests, the BER is measured under the worst conditions using a stressed signal with added jitter and voltage noise. Using the MP1900A series with the Jitter Modulation Source MU181500B, Noise Generator MU195040A with CDR function for adding various Jitter types and SSC and the Jitter Tolerance Test MX183000A-PL001 software, supports receiver tolerance tests in conformance with the various interface standards. The MP1900A series offers strong support for receiver stressed input tolerance tests by high-quality output signal before jitter and noise addition and high-linearity jitter and noise addition functions.

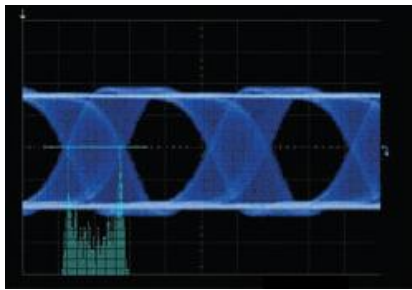

Sinusoidal Jitter(SJ)

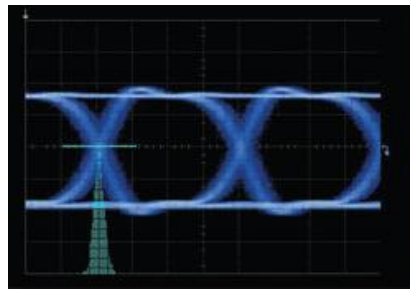

Random Jitter(RJ)

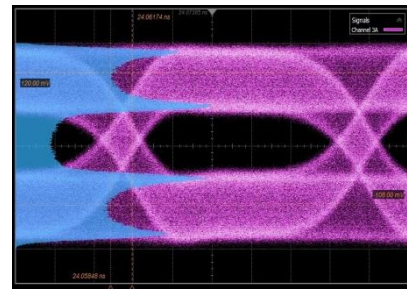

CM/DM Noise

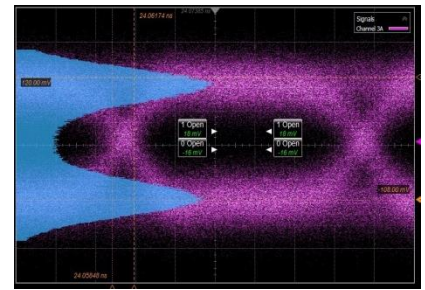

White Noise

Jitter Tolerance Test Function (MX183000A-PL001)

- High-versatility Jitter Tolerance measurements
- PHY Device Jitter Tolerance tests by impressing SJ/RJ/BUJ
- Standards-compliant Mask measurements
- Fast measurement times using low error rate estimation function, such as 1E-12 and 1E-15
- Tolerance measurements versus device characteristics using four Binary, Upward, Downward, Binary + Linear methods

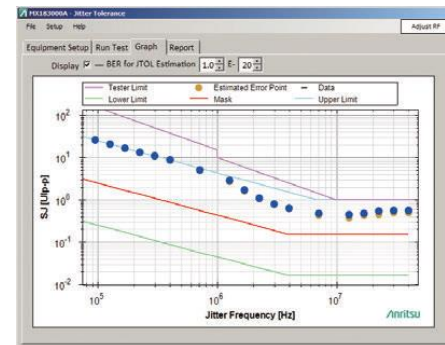

Low Error Rate Estimation Jitter Tolerance Measurements

Built-in PCI Express Link Training and LTSSM Analysis Functions

High-speed serial interfaces require good interconnectivity between devices and equipment, and it is important to identify whether a dropped Link is caused by physical or logical errors. The all-in-one MP1900A series supports Physical layer evaluations for PCIe Gen1 to Gen5 and future Gen6 receivers, in addition to having Link Training for securing normal operation, also has functions for detecting and analyzing LTSSM (Link Training Status State Machine) fault transitions to improve detection efficiency.

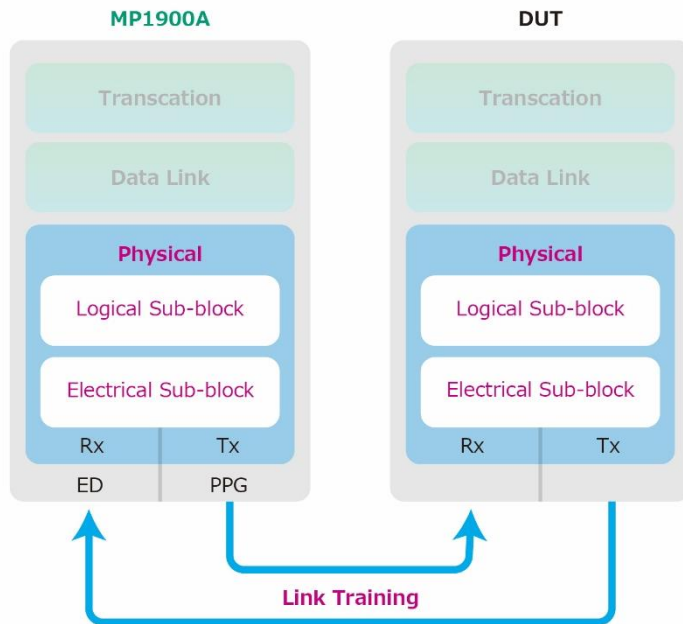

Supports physical layer measurements of add-in cards and system boards

- Tx/Rx Link Equalization Response Test
- Rx Link Equalization Test
- Receiver Jitter Tolerance Test

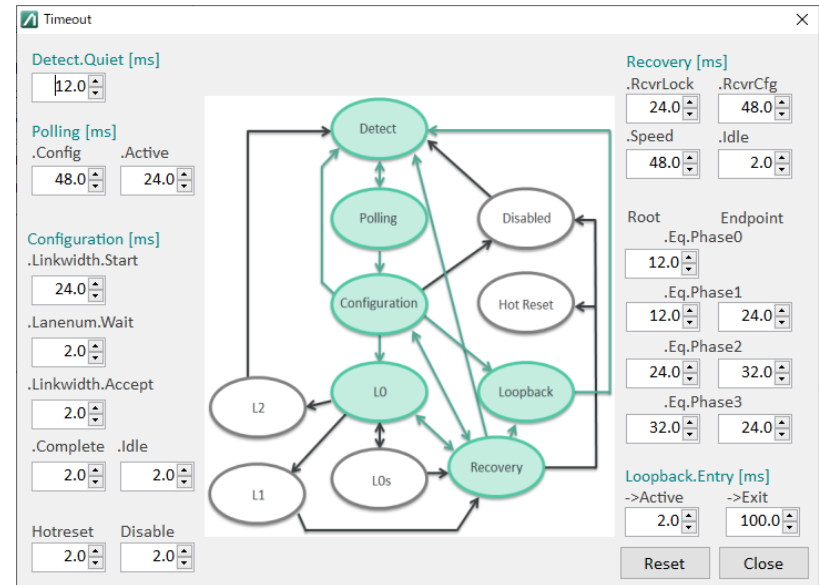

PCI Express Link Training State transitions (MX183000A-PL021)

Link Problem Test using Built-in Sequence Editor Function Advancing beyond

The PCI-Express and USB 3.2 tests require evaluation by BER measurement when negotiation with the Link partner is completed. If this negotiation is not completed, although it is possible to use the LTSSM analysis function to troubleshoot the problem state, the built-in Sequence Editor function can troubleshoot the problem using detailed cause analysis. This function can be used to resolve negotiation problems quickly.

Identifying Link non-negotiation state using LTSSM function

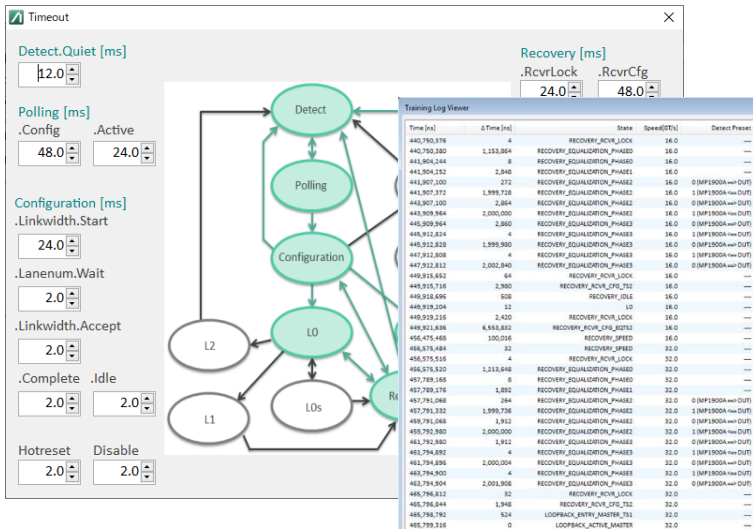

Identifying problem parameters using status data occurrence times, sequence and encode data editing

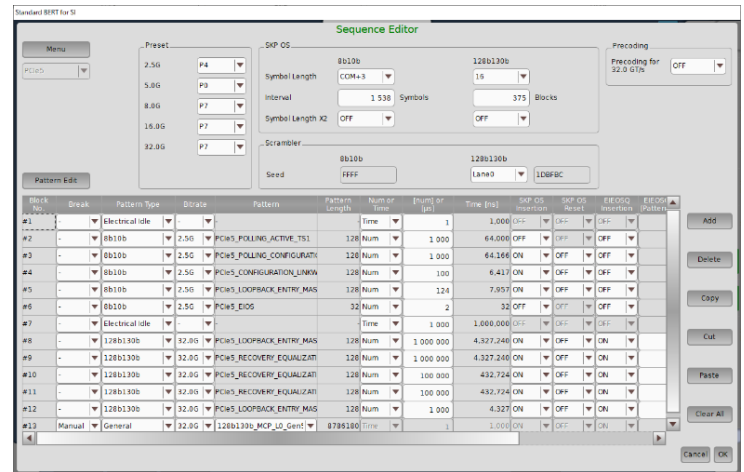

Sequence Editor Function (MU195020A-050): PCIe 1/2/3/4, USB 3.2 Gen1/2
 Sequence Editor Function PCIe 5 Extension (MU195020A-051): PCIe 5 Extension

New Features of MP1900A Series

- 8-slot Platform
- 32G SI PPG/ED and Noise Generator Modules
- PCI Express Link Training and LTSSM Analysis Functions
- Backward Compatibility with SQA Series MU181000B Synthesizer, Jitter Modulation Source MU181500B, and 32G PPG/ED MU183020A/40B

Signal Quality Analyzer-R MP1900A



MX183000A-PL021 PCIe
MX183000A-PL025 PCIe Gen5 extension
MX183000A-PL022 USB
MX183000A-PL023 USB x2
Link Training (software)

21G/32G bit/s SI PPG MU195020A



21G/32G bit/s SI ED MU195040A



Noise Generator MU195050A



21G/32G bit/s SI PPG MU195020A Features

- Bit rate of 2.4 to 21 Gbit/s or 32.1 Gbit/s
- 1ch/2ch Selection
- 10Tap Emphasis built-in
- Data Output Amplitude 0.1 Vp-p to 1.3 Vp-p (Single-end)
0.2 Vp-p to 2.6 Vp-p (Differential)
- Low Intrinsic Jitter output of 115 fs rms (typ.)
- Tr/Tf (20%-80%) of 12 ps (typ.)
- Multi-channel synchronization function
- NRZ/PAM4 support (PAM4 uses 2ch Data out + G0375A remote head)
- PCI Express / USB Link Training

21G/32G bit/s SI PPG MU195020A



Data1 (differential) Data2 (differential)

- 10Tap Emphasis
- High-Quality Output Waveforms
- Multi-channel Synchronization

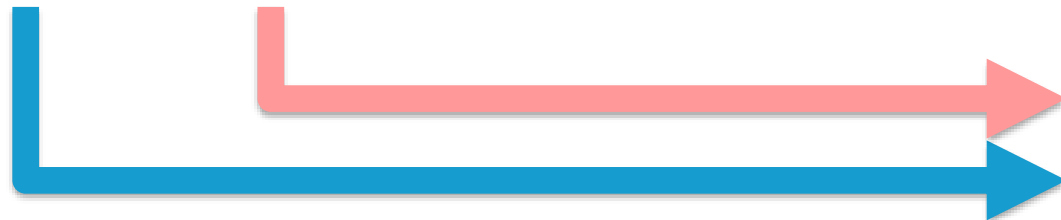

DUT

MU195020A PPG Data Output Waveforms

Low Intrinsic Jitter Data Output Waveforms for Signal Integrity Analysis

PRBS $2^{31}-1$, 1 Vp-p (Single end, 70 GHz observed with oscilloscope)

32.1 Gbit/s

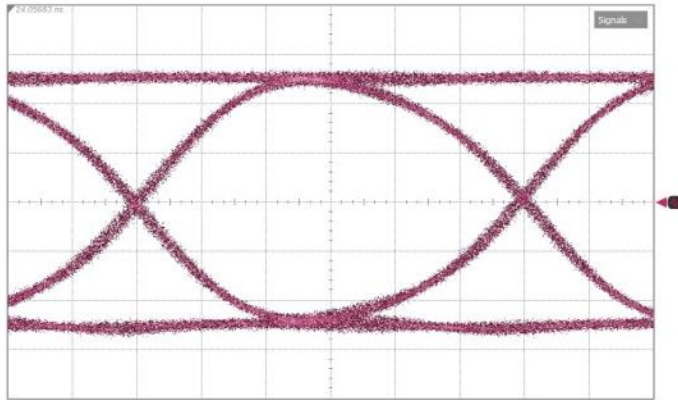

21 Gbit/s

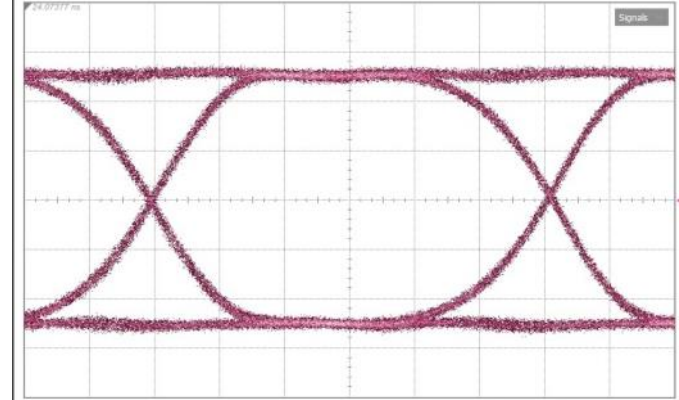

28.1 Gbit/s

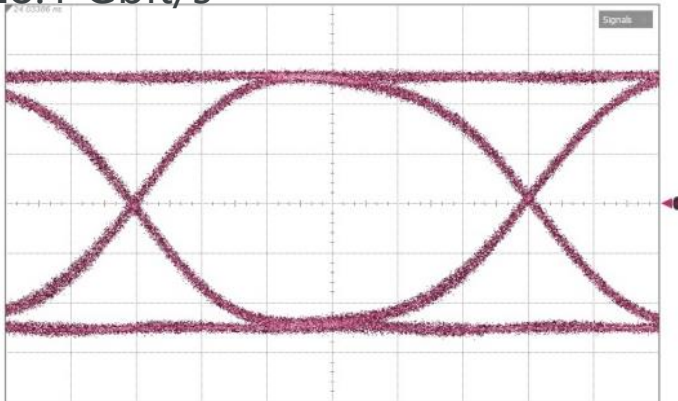

Low Intrinsic Jitter 115 fs (rms) @ 28.1 Gbit/s
("1010..." pattern)

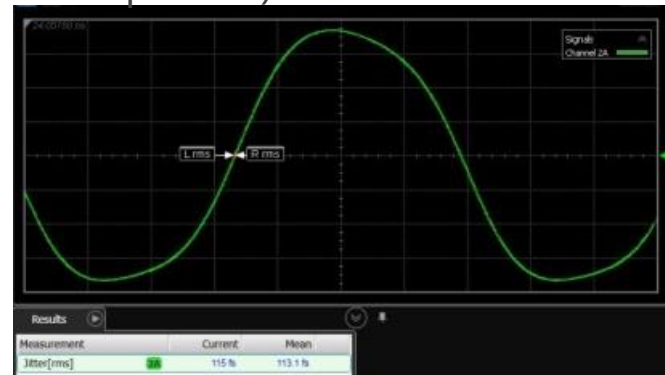

MU195020A PPG Data Output 10Tap Emphasis

Flexible Support for High-speed Device with Long-channel Design Evaluations

- 10Tap Emphasis
- Control up to 20 dB
- Pre-Emphasis output with peak output amplitude of 1.5 Vp-p

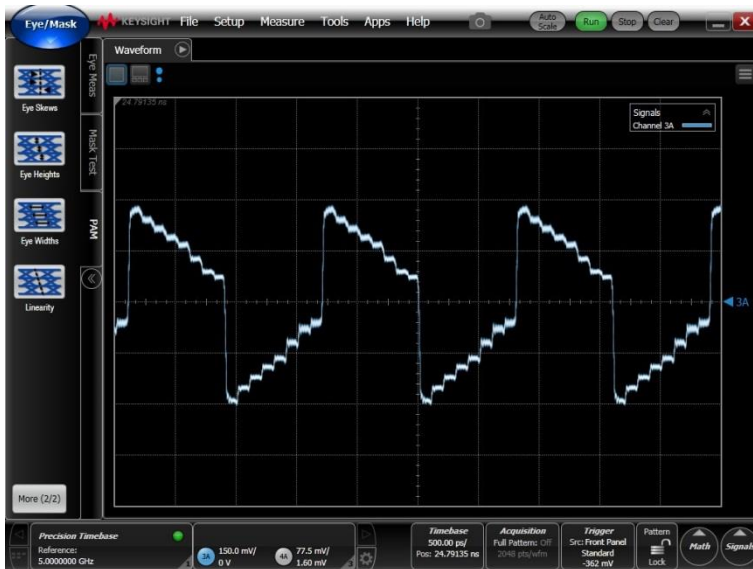

Waveform for correcting transmission path loss

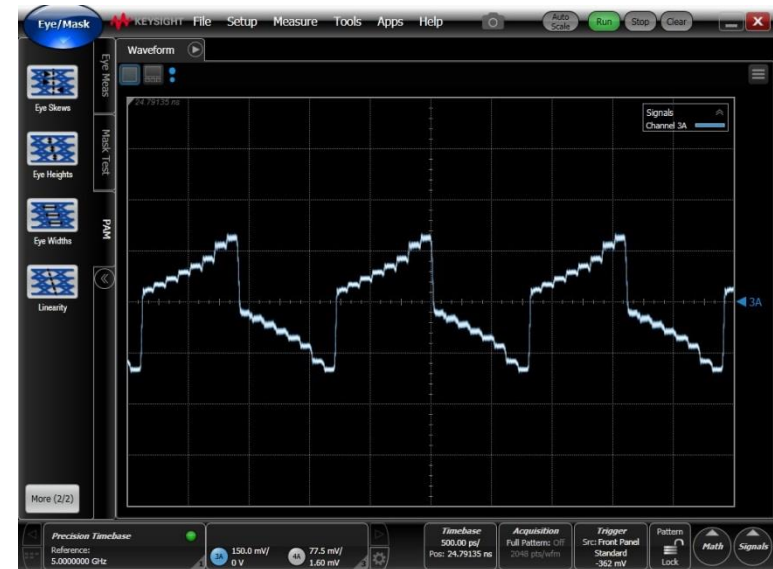

Waveform emulating signal loss

Voltage control at each 1 bit for 10-bit time period

MU195020A Data Output Variable ISI

Shorter Development Period by Eliminating Need for Multiple Test PC Boards
Simple and High-Reproducibility Design Tests of High-Speed Device Channel Loss Dependency

- Emulate channel loss by controlling Emphasis and generate loss-compensated signals
- Automatically calculate Emphasis setting using S-parameter

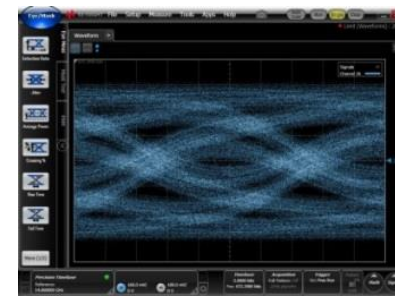
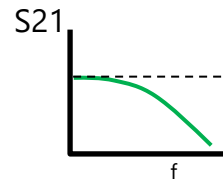

Emulate channel loss
And generate loss-compensated signals (Variable ISI option)

CEI-28G, 14 dB loss typical waveform (ISI function)

Manual Setting

File Operation: Recall, Store, Initialize

Standard/Preset: USER, Pre-Emphasis, Preset0

Amplitude: 0.842 Vpp

Output Monitor

Cursor	dB
Cursor3	1.200
Cursor2	-1.300
Cursor1	4.000
Post	
Cursor1	6.300
Cursor2	2.100
Cursor3	1.700
Cursor4	1.000
Cursor5	0.600
Cursor6	0.300

Simulated Pulse [Vpp]

Parameter	Value
Va	1.374
Vb	1.086
Vc	0.996
Vd	0.949
Ve	0.902
Vf	0.879
Vg	0.852
Vh	0.806
Vi	0.763
Vj	0.984

- **Manual Setting:**
Correct signal for target Eye Height/Width using 10Tap Emphasis function
- **Channel Emulator:**
Emulate S2P and S4P data loss insertion, and perform Emphasis compensation
- **ISI:**
Emulate ISI using CEI-28G/25G Nyquist frequency loss setting

Multiplexing, high-bit-rate and crosstalk tests are supported by the multi-channel Data output, pattern synchronization and skew control functions for easy flexible evaluations of future high-bit-rate and multi-channel interfaces.

Sync Channel Number	Supported Function	Application	Equipment Configuration
2ch	2ch Combination	32G PAM4 Generation 2:1 MUX Evaluation	MU195020A 2ch PPG x1
	Channel Synchronization		
4ch	64G x 2ch Combination	64G PAM4 Generation 4:1 MUX Evaluation	MU195020A 2ch PPG x2
	Channel Synchronization	QSFP28 Evaluation	

• 2ch Combination

Supports shift to "a1b1 a2b2 . . ." pattern and PAM4 output.

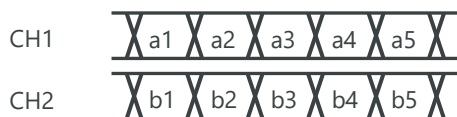

• 64G x 2ch Combination

Supports shift to "a1b1c1d1 a2b2c2d2 . . ." pattern and 64 Gbaud PAM4 output from two 32G PPG units, 4CH.

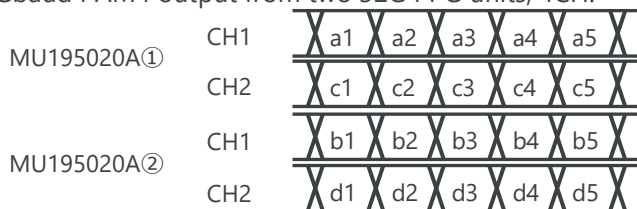

• Channel Synchronization

One 16ch MP1900A supports parallel interface evaluations, crosstalk tests and D/A converter evaluations as well as synchronized output for up to four MP1900A units.

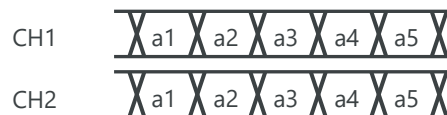

21G/32G bit/s SI ED MU195040A Features

- Bit rate of 2.4 to 21 Gbit/s or 32.1 Gbit/s
- 1ch/2ch selection
- Built-in multi-band CTLE function
 - Peak frequency: 14, 8, 4 GHz switchable
 - Gain control: 0 to -12 dB control
- Data input amplitude: 0.05 to 1.0 Vp-p (Single-end)
- Input sensitivity @ 28.1Gbit/s NRZ: 15 mV (Eye Height) (typ.); 22 mVp-p (Eye amplitude)
@ 28.1Gbit/s PAM4: 30 mV/Eye(Eye Height) (typ.); 150 mVp-p (Eye amplitude)
- Auto-measurements (Auto-search/Adjust, Eye Contour, Bathtub, Jitter Tolerance)
- Clock Recovery: 2.4 to 32.1 Gbit/s, SSC support
- PCI Express / USB Link Training

MU195040A 21G/32G bit/s SI ED



Data1 (differential)

Data2 (differential)

- Multi-band CTLE
- High-sensitivity input
- CDR supporting SSC

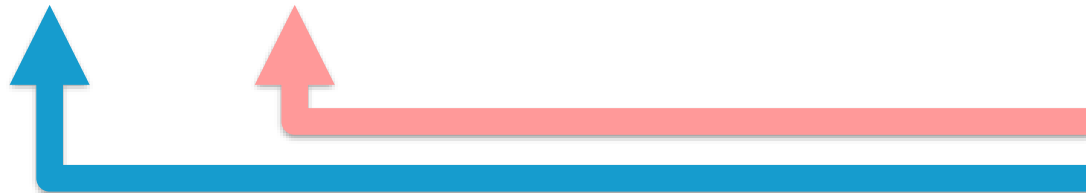

DUT

MU195040A ED Data Input CTLE/Clock Recovery Functions

Supports input receiver measurements for CEI-28G, PCIe Gen 3 to Gen 5 using 3-band CTLE (peak frequency of 14, 8, and 4 GHz)

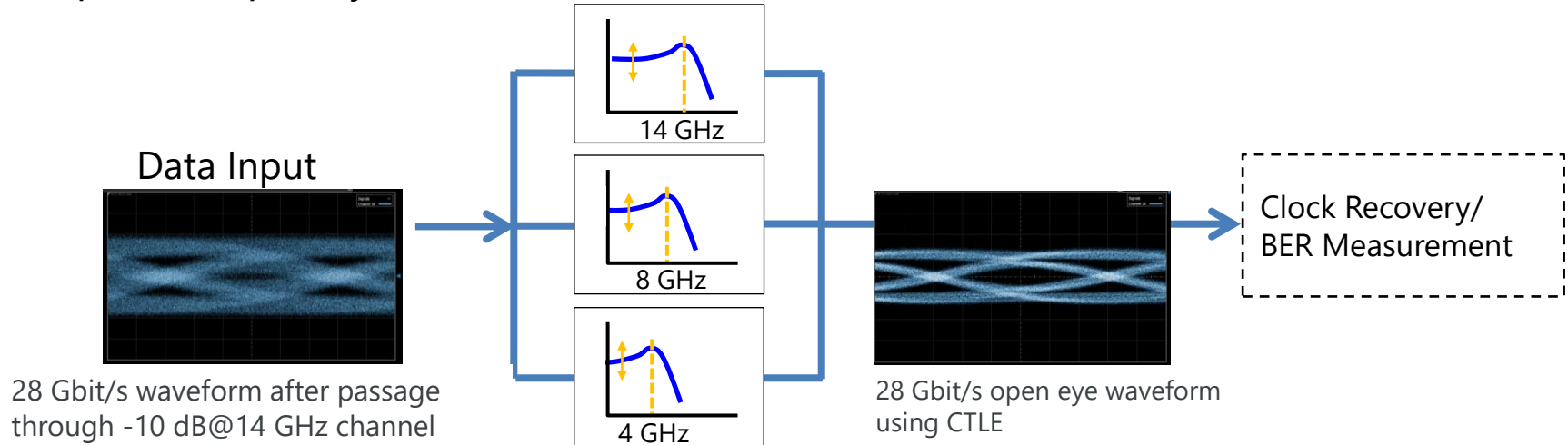

Supports SSC to implement Eye analysis for input signals with added Jitter

- 2.4 Gbit/s to 32.1 Gbit/s (extracts Clock from Data1 input signal)
- External Clock/Clock Recovery/Clock and Data Recovery_SSC support switching function

Data Recovery On when setting "Clock and Data Recovery", SSC support

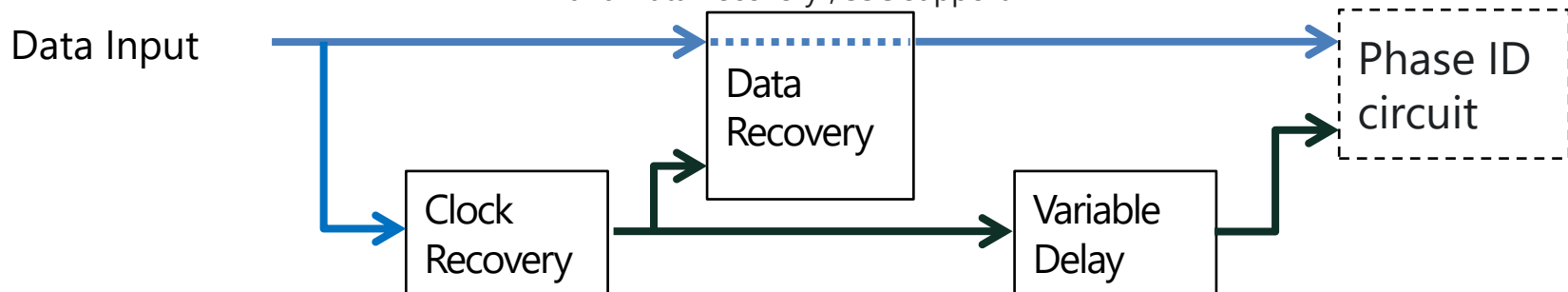

Higher-accuracy Eye analysis is supported using the auto-measurement and auto-analysis functions, such as Auto Search/Auto Adjust, Bathtub, Eye Contour, Eye Margin, and PAM BER measurement that make use of the measurement high-input-sensitivity performance.

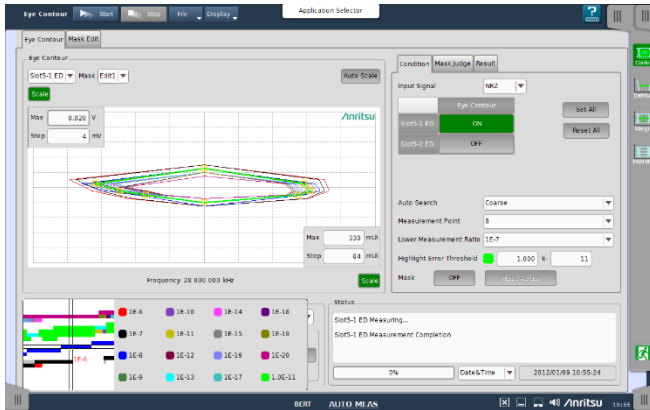

Example of Eye Contour Measurement at Input of Small 50 mVp-p Signal

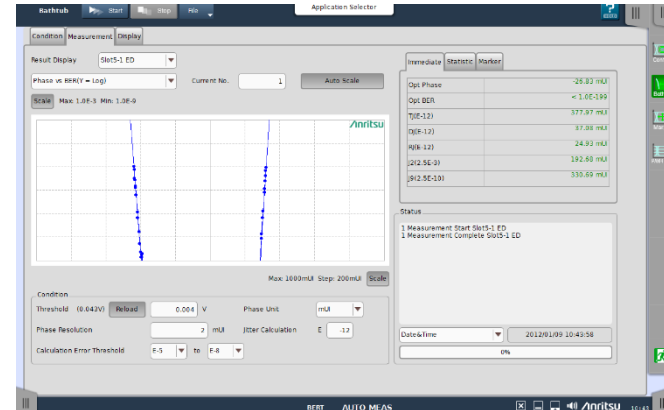

Bathtub Measurement Example



Example of Eye Contour Measurement at Input of PAM4 Signal

Noise Generator MU195050A Features

Supports Voltage Noise Tolerance tests specified by CEI and IEEE802.3 for backplane, PCIe, and Thunderbolt measurements

- Noise addition to Data signals up to bit rates of 32.1 Gbit/s
- 2ch output
- CMI/DMI/White noise support
 - Common mode noise frequency: 0.1 GHz to 6 GHz
 - Differential mode noise frequency: 2 GHz to 10 GHz
 - White noise band: 10 GHz; Crest Factor: >5
- Supports external noise input

MU195020A



MU195050A
Noise Generator



Data1 (differential)

Data2 (differential)

External input

- Built-in CMI/DMI/White noise
- 2ch output

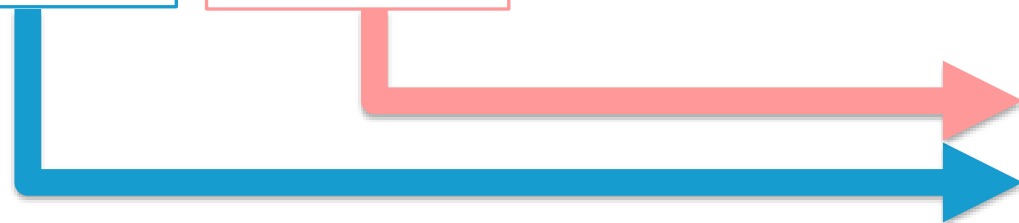

DUT

MU181500B Jitter SSC Profile Function

The new SSC Profile standard for USB 4, Display Port, etc., makes it easy to test SSC compliance of the DUT receiver clock recovery, etc.

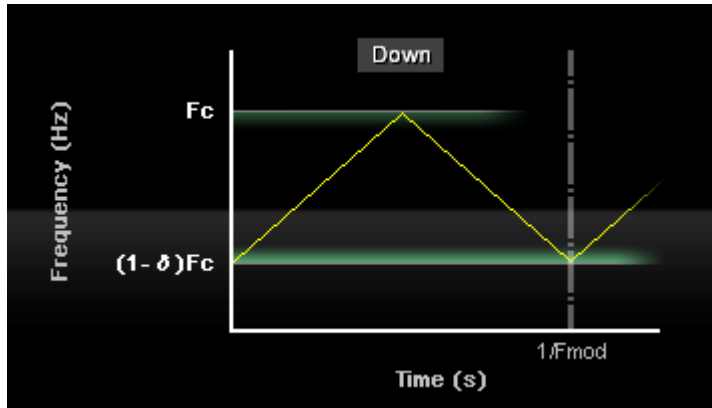

Previous Triangular

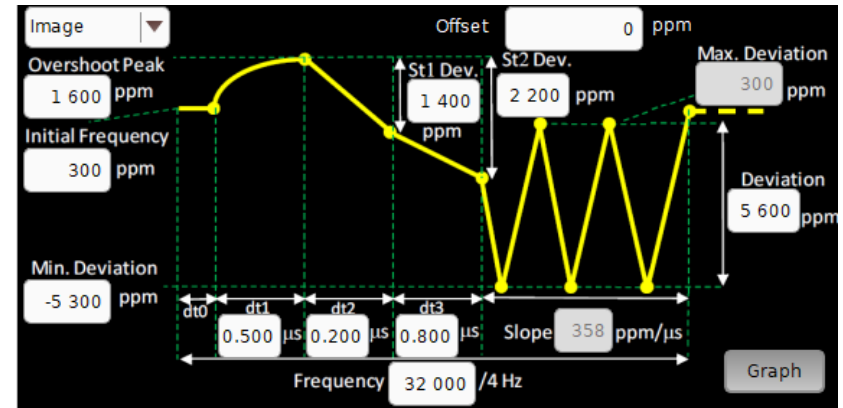

USB 4 SSC Profile (image)

List	Initial Frequency	300 ppm	Offset	0 ppm	
Frequency	32 000 Hz	Frame Divide Ratio	4	Frame Frequency	8 000 Hz
Deviation	5 600 ppm	Min. Deviation	-5 300 ppm	Max. Deviation	300 ppm
Window	Shape	δDeviation[ppm]	Time[μs]	Slope[ppm/μs]	
dt1	Sinusoidal	1 300	1.500	---	
dt2	Linear	-1 400	1.500	-933	
dt3	Linear	-800	0.800	-1 000	
dt4	Linear	-1 200	0.700	-1 714	
Steady-State	Linear	5 600	87.890	358	

Variable Profile (List)

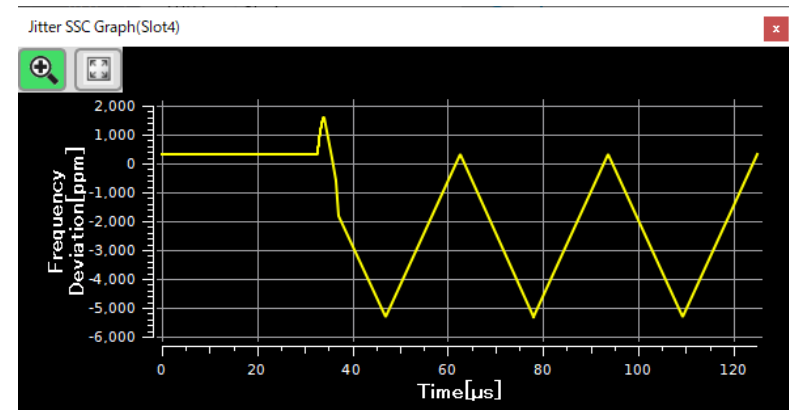

Variable Profile (Graph)

MP1900A Main Unit Features

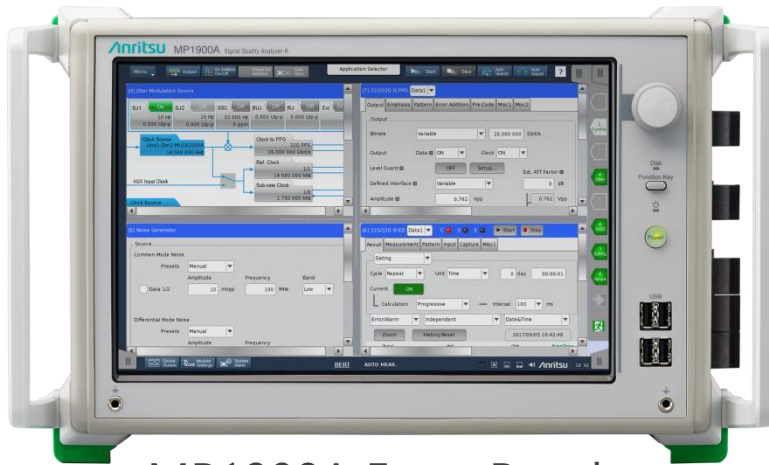

MP1900A Front Panel

- 8 Slots
- Install up to eight 2ch PPG and ED modules
- Synchronize up to four MP1900A main units
→ Expansion to 2 Tbit/s
- Backwards compatibility with existing MP1800A modules



MP1900A Side Panel

- Touch Screen
- GPIB x 1, and Ethernet x 2
- USB x 6, HDMI x 1, and D-SUB x 1
- Windows 10 IoT Enterprise

MP1900A 8-slot Main Unit Expandability

Future-proof Main Unit Expandability

- One Main Unit Supports 16ch Transmissions for Future High Bit Rates

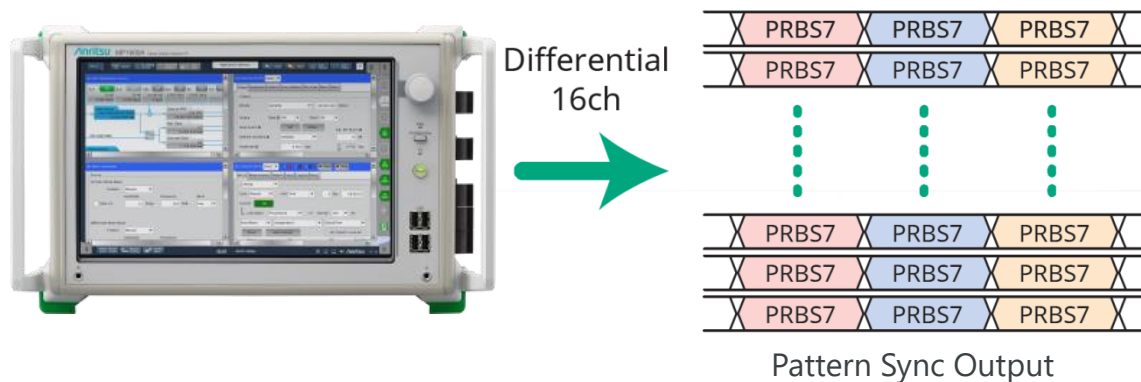

- Multi-channel Synchronized Output of Four MP1900A Main Units



System View User Interface and Improved Operability using Multiple Windows

Operability is improved by the large 12.1-inch LCD touch panel and intuitive GUI. The newly developed System View user interface displays easy-to-understand system function blocks with help guidance for system settings and easy operation of each module.

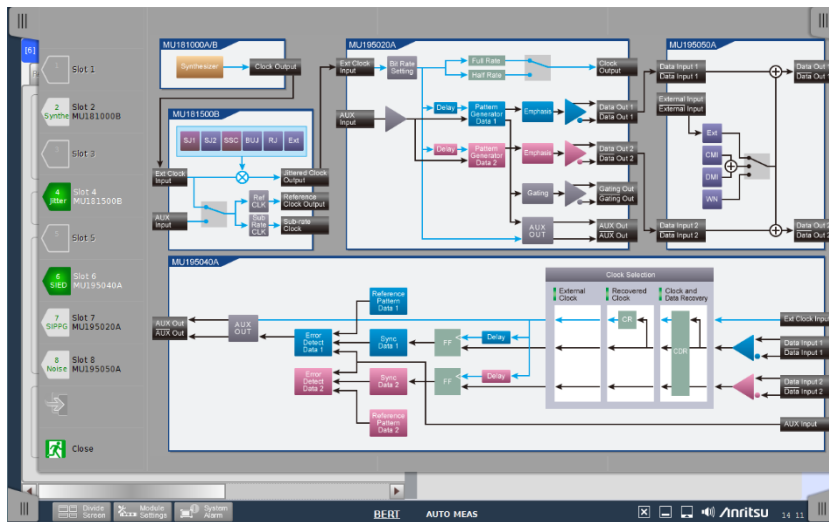

System View User Interface

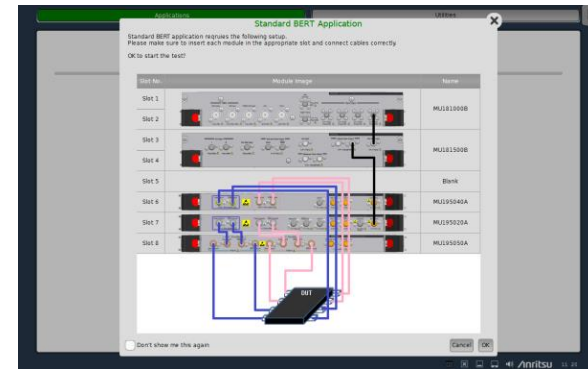

Setup Instructions



4ch Multi-channel Measurement Results on One Screen

Operation while EZ SCPI Creator is ON creates remote command strings automatically, making it easy to describe remote commands.

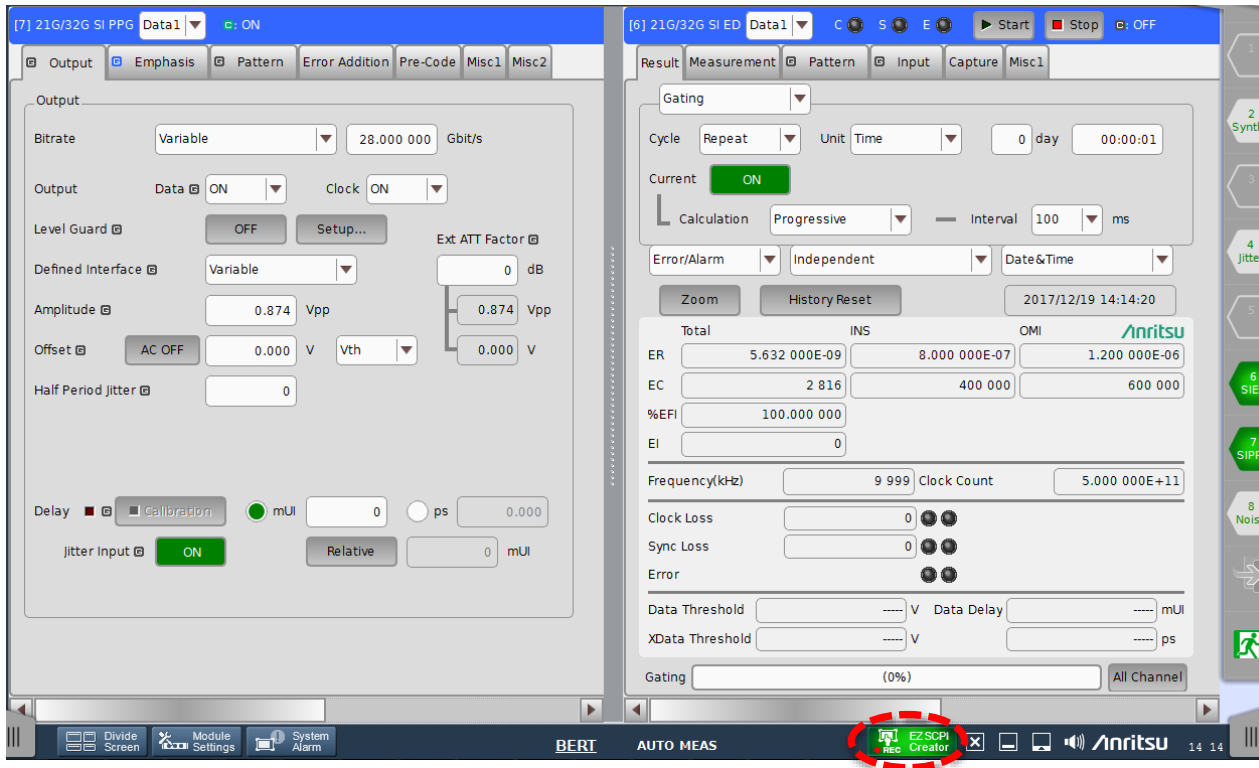

EZ SCPI Creator ON

For example, executing the following operations:

- Set PPG Amplitude
- Set PPG Pattern Type
- Set PPG PRBS Length
- Set Output On
- Start ED measurement



Automatically generates these operation remote commands

```
:UENTry:ID 1; :MODule:ID 7; :INTERface:ID 1; :OUTPut:DATA:AMPLitude DATA,0.574
:UENTry:ID 1; :MODule:ID 7; :INTERface:ID 1; :SOURce:PATtern:TYPE PRBS
:UENTry:ID 1; :MODule:ID 7; :INTERface:ID 1; :SOURce:PATtern:PRBS:LENG 31
:SOURce:OUTPut:ASET ON
:UENTry:ID 1; :MODule:ID 6; :INTERface:ID 1; :SENSe:MEASure:STAR
```



PCI Express Test Solution

PCIe Tx LEQ/Rx Compliance Test

- Combination of best-performance BERT MP1900A and preferred oscilloscope -

Shorter test times and reduced investment cost

- Supports Combination with Lecroy/Tektronix/Keysight Real-Time Oscilloscopes
- Automated Rx CEM and Base Tests: Calibration, Link EQ and Automated Tx Test
- Protocol Aware: Link Training/Equalization and LTSSM Analysis
- High-Expandability 32G Multichannel BERT for PCIe1 to 5

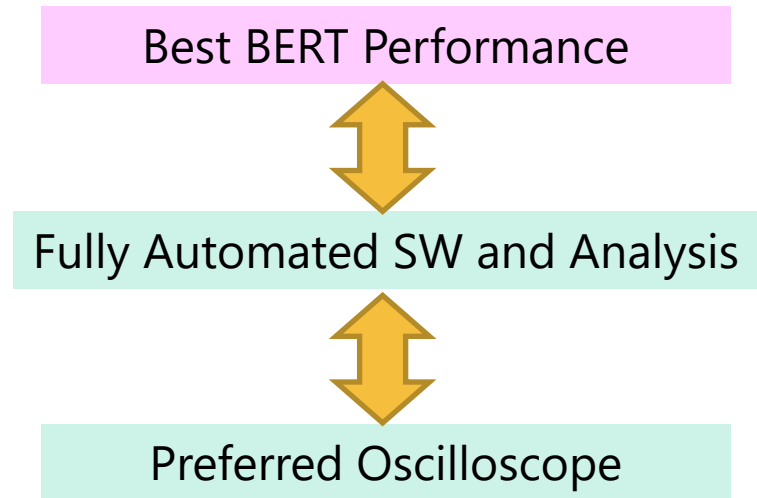
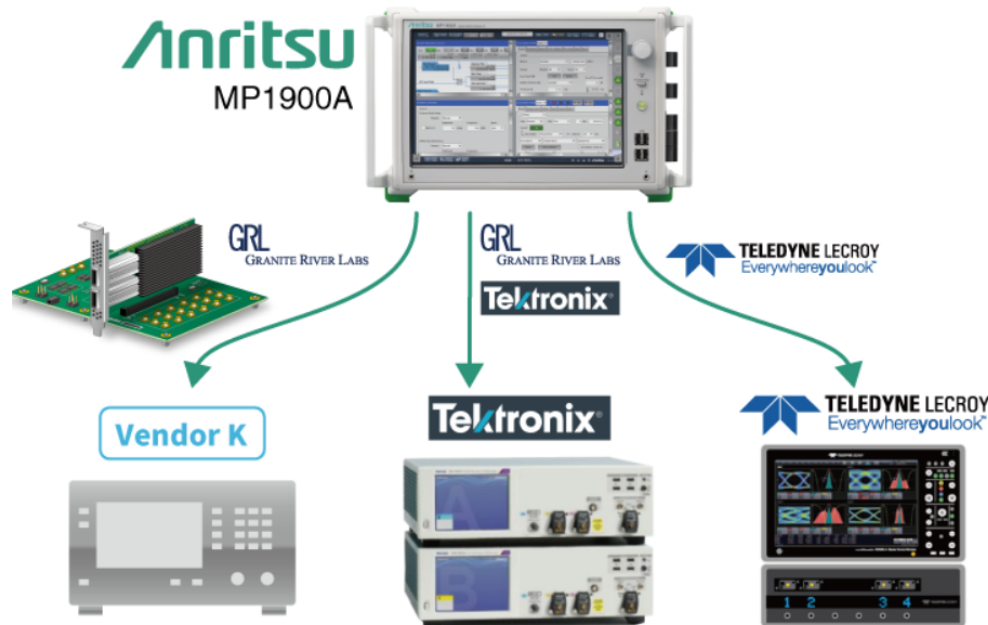

MP1900A Series PCI Express Test Solution

Measurement Item	Supported Software
Transmitter Test	*
Tx Response Time	MX183000A-PL021 PL025 (Gen5)
Stressed Signal Calibration	*
Transition to Loopback State	MX183000A-PL021 PL025 (Gen5)
Rx Link Equalization Test	MX183000A-PL021
Jitter Tolerance Test	MX183000A-PL001
PLL Loop Bandwidth Test	*

*Contact your sales representative about expected future support.

MP1900A Series PCI Express Receiver Test Solution

- All-in-one PCI Express Gen1 to 5 solution
- Wideband bit rate of 2.4 Gbit/s to 21 Gbit/s, expansion to 32.1 Gbit/s
No need for hardware upgrade to support Gen5 (32 GT/s)
- Automated LEQ test (Protocol Aware) with LTSSM event trigger function
- Low-Jitter test signals and high-input sensitivity performance
- Link Training and LTSSM analysis function
- SKP Order set and 8B/10B, 128B/130B coding
- Built-in noise (CMI and DMI) and Jitter (SJ, RJ, BUJ and SSC) addition function
- Supports both Common (MU181000B-002) and Separate Clock architectures
- Establishes Gen5 return path using external Re-Driver set

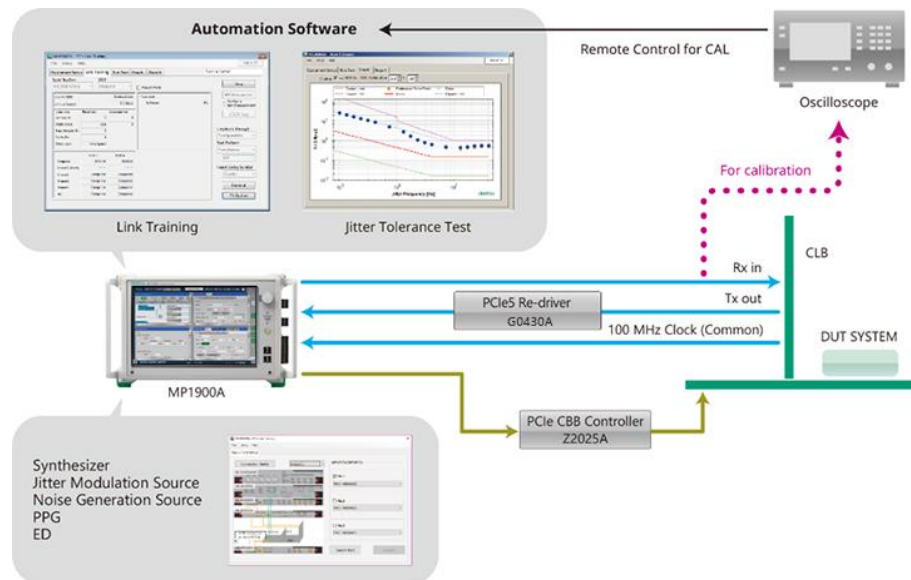

PCI Express Link Training, LTSSM Analysis and Jitter Tolerance Measurements (1/5)

PCI Express PHY IP Device Rx Test Sequence

Stress Signal Calibration

Transition to Loopback Status

Stress Signal Input Test

Applicable Software

Automation Software:
GRL-PCIE5-BASE/CEM-RXA
or QPHY-PCIE-Tx-Rx

Link Training Software:
MX183000A-PL021 (Gen1 to 4)
MX183000A-PL025 (Gen5)

- Jitter Tolerance Margin Test:
MX183000A-PL001
- or
- Jitter Sweep Test (Pass/Fail):
GRL-PCIE5-BASE/CEM-RXA
or QPHY-PCIE-Tx-Rx

Automation Software
For Calibration

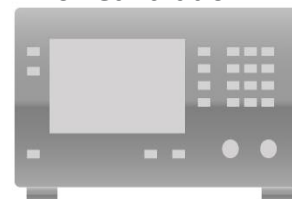
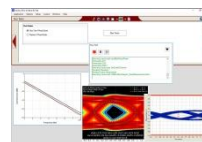

ISI Calibration Channel

Test Board

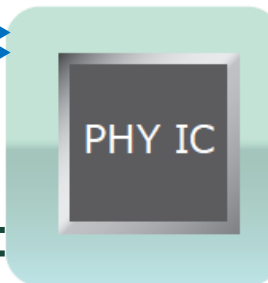
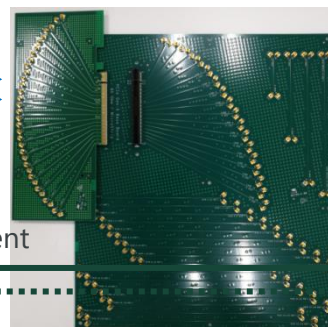

BER Measurement

PCI Express Link Training, LTSSM Analysis and Jitter Tolerance Measurements (2/5)

Combining the PCIe Link Training MX183000A-PL021 and Jitter Tolerance Test MX183000A-PL001 software supports tests from the Link with the DUT to the Jitter Tolerance test measurements required by PCI Express receiver tests.

Displays Link Training Settings and Results

Automatic Measurement of Receiver Jitter Tolerance

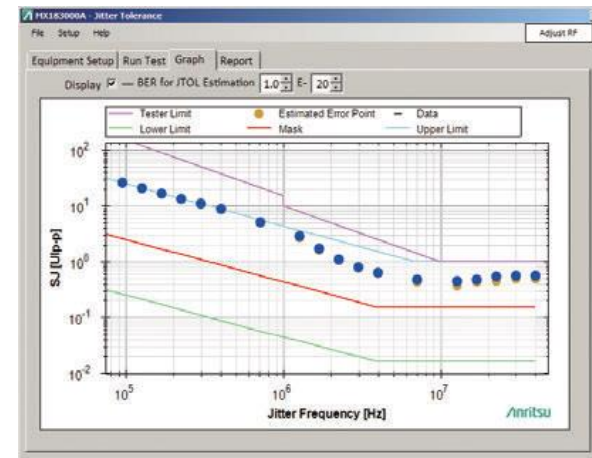
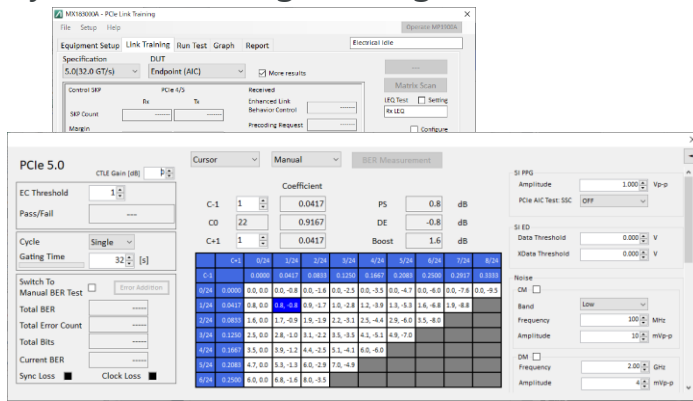

Item	MX183000A-PL021 Specifications	PL025 Extension
Standard	PCI Express Rev 1.x (2.5 GT/s), 2.0 (5 GT/s), 3.x (8 GT/s), 4.0 (16 GT/s)	Gen5 (32 GT/s)
Test Pattern	Compliance (MCP, CP), PRBS (7, 9, 10, 11, 15, 20, 23, 31)	
LTSSM State	Transition to Detect, Polling, Configuration, Recovery, Loopback	
Loopback Through	Configuration, Recovery	
TS Setting Parameters	SKP Insertion, 8B/10B, 128B/130B, FTS, Link Number, Lane Number, Scrambling	

PCI Express Link Training, LTSSM Analysis and Jitter Tolerance Measurements (3/5)

Shorter Development Period by LTSSM Analysis Functions for Troubleshooting Cause of Link Faults

Examine each state transition time and path from "Detect" to "Loopback".

Check results for each state transition using Training Log Viewer.

The Timeout window displays various timing parameters for different states and transitions:

- Detect.Quiet [ms]:** 12.0
- Polling [ms]:** .Config: 48.0, .Active: 24.0
- Configuration [ms]:** .Linkwidth.Start: 24.0, .Lanenum.Wait: 2.0, .Linkwidth.Accept: 2.0, .Complete: 2.0, .Idle: 2.0
- Hotreset Disable:** 2.0
- Recovery [ms]:** .RcvrLock: 24.0, .RcvrCfg: 48.0, .Speed: 48.0, .Idle: 2.0
- Root Endpoint:** .Eq.Phase0: 12.0, .Eq.Phase1: 12.0, .Eq.Phase2: 24.0, .Eq.Phase3: 32.0
- Loopback.Entry [ms]:** ->Active: 2.0, ->Exit: 100.0

The diagram shows state transitions between Detect, Polling, Configuration, L0, L1, L0s, Loopback, Recovery, L2, Disabled, and Hot Reset.

Time [ns]	Δ Time [ns]	State	Speed[Gt/s]	Detect Preset
440,750,376	4	RECOVERY_RCVR_LOCK	16.0	---
440,750,380	1,153,864	RECOVERY_EQUALIZATION_PHASE0	16.0	---
441,904,244	8	RECOVERY_EQUALIZATION_PHASE0	16.0	---
441,904,252	2,848	RECOVERY_EQUALIZATION_PHASE1	16.0	---
441,907,100	272	RECOVERY_EQUALIZATION_PHASE2	16.0	0 (MP1900A ==> DUT)
441,907,372	1,999,728	RECOVERY_EQUALIZATION_PHASE2	16.0	1 (MP1900A <== DUT)
443,907,100	2,864	RECOVERY_EQUALIZATION_PHASE2	16.0	0 (MP1900A ==> DUT)
443,909,964	2,000,000	RECOVERY_EQUALIZATION_PHASE2	16.0	1 (MP1900A <== DUT)
445,909,964	2,860	RECOVERY_EQUALIZATION_PHASE3	16.0	0 (MP1900A ==> DUT)
445,912,824	4	RECOVERY_EQUALIZATION_PHASE3	16.0	1 (MP1900A <== DUT)
445,912,828	1,999,980	RECOVERY_EQUALIZATION_PHASE3	16.0	0 (MP1900A ==> DUT)
447,912,808	4	RECOVERY_EQUALIZATION_PHASE3	16.0	1 (MP1900A <== DUT)
447,912,812	2,002,840	RECOVERY_EQUALIZATION_PHASE3	16.0	0 (MP1900A ==> DUT)
449,915,652	64	RECOVERY_RCVR_LOCK	16.0	---
449,915,716	2,980	RECOVERY_RCVR_CFG_TS2	16.0	---
449,918,696	508	RECOVERY_IDLE	16.0	---
449,919,204	12	L0	16.0	---
449,919,216	2,420	RECOVERY_RCVR_LOCK	16.0	---
449,921,636	6,553,832	RECOVERY_RCVR_CFG_EQTS2	16.0	---
456,475,468	100,016	RECOVERY_SPEED	16.0	---
456,575,484	32	RECOVERY_SPEED	32.0	---
456,575,516	4	RECOVERY_RCVR_LOCK	32.0	---
456,575,520	1,213,648	RECOVERY_EQUALIZATION_PHASE0	32.0	---
457,789,168	8	RECOVERY_EQUALIZATION_PHASE0	32.0	---
457,789,176	1,892	RECOVERY_EQUALIZATION_PHASE1	32.0	---
457,791,068	264	RECOVERY_EQUALIZATION_PHASE2	32.0	0 (MP1900A ==> DUT)
457,791,332	1,999,736	RECOVERY_EQUALIZATION_PHASE2	32.0	1 (MP1900A <== DUT)
459,791,068	1,912	RECOVERY_EQUALIZATION_PHASE2	32.0	0 (MP1900A ==> DUT)
459,792,980	2,000,000	RECOVERY_EQUALIZATION_PHASE2	32.0	1 (MP1900A <== DUT)
461,792,980	1,912	RECOVERY_EQUALIZATION_PHASE3	32.0	0 (MP1900A ==> DUT)
461,794,892	4	RECOVERY_EQUALIZATION_PHASE3	32.0	1 (MP1900A <== DUT)
461,794,896	2,000,004	RECOVERY_EQUALIZATION_PHASE3	32.0	0 (MP1900A ==> DUT)
463,794,900	4	RECOVERY_EQUALIZATION_PHASE3	32.0	1 (MP1900A <== DUT)
463,794,904	2,001,908	RECOVERY_EQUALIZATION_PHASE3	32.0	0 (MP1900A ==> DUT)
465,796,812	32	RECOVERY_RCVR_LOCK	32.0	---
465,796,844	1,948	RECOVERY_RCVR_CFG_TS2	32.0	---
465,798,792	524	LOOPBACK_ENTRY_MASTER_TS1	32.0	---
465,799,316	0	LOOPBACK_ACTIVE_MASTER	32.0	---

PCI Express Link Training, LTSSM Analysis and Jitter Tolerance Measurements (4/5)

Generate trigger at LTSSM transition timing to support examination using oscilloscope waveform.

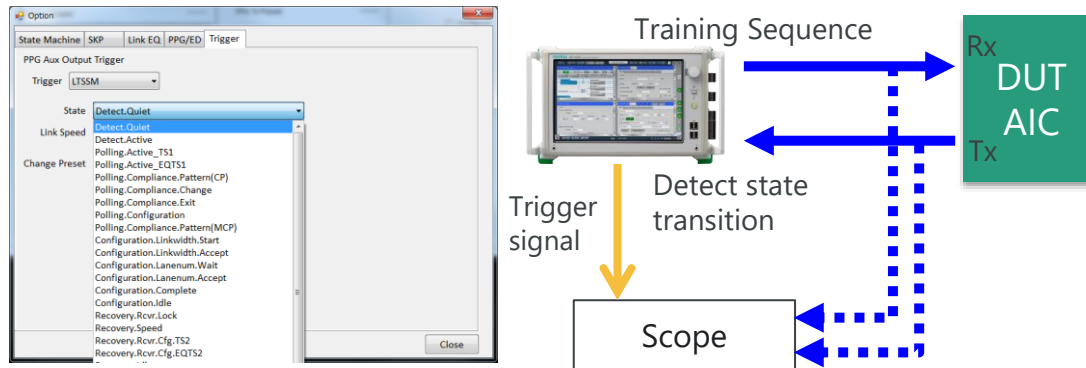

Supports both common and separate Refclock test architectures and SRIS

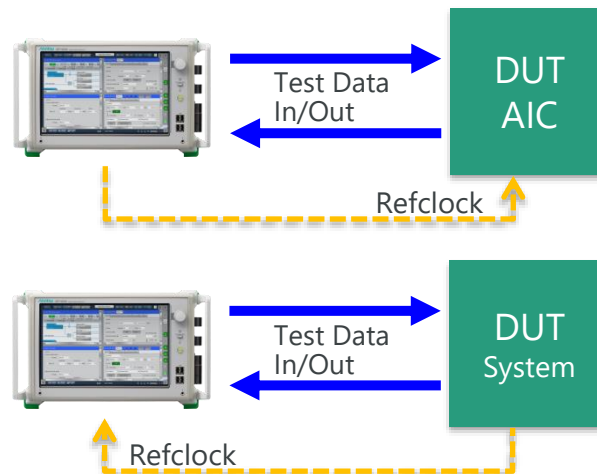

PCI Express Link Training, LTSSM Analysis and Jitter Tolerance Measurements (5/5)

Matrix Scan Function

To secure high-quality communications with the Link partner, the best combination of the Tx-side EQ and Rx-side EQ must be selected.

The Matrix scan function scans for the best Tx EQ setting at the receiver to find the best setting automatically at the receiver

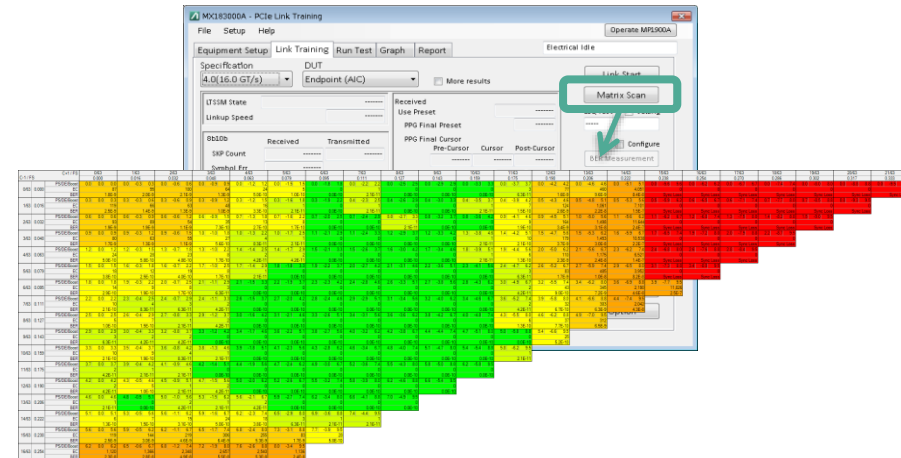
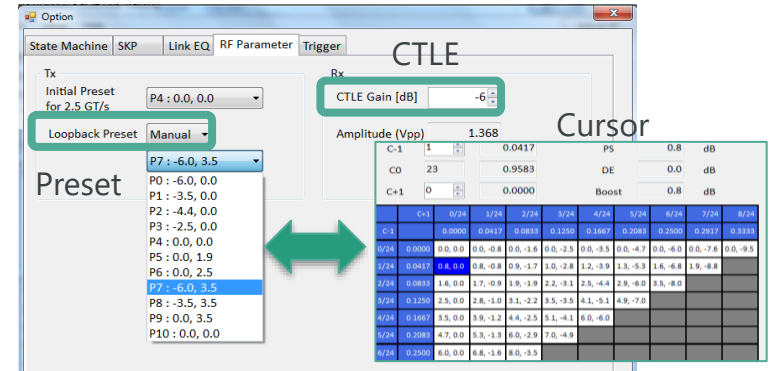

Graphical display of BER measurement results for each DUT Tx Preset setting

PCI Express Receiver Test Recommended Equipment List (1/2)

Model	Name	Option	Qty	Remark
MP1900A	Signal Quality Analyzer-R	-	1	
MU181000B	12.5GHz 4port Synthesizer	002	1	
MU181500B	Jitter Modulation Source	-	1	
MU195020A	21G/32G bit/s SI PPG	001*, 010, 011	1	*Add Opt-001 for expansion to Gen5 (32 G)
MU195040A	21G/32G bit/s SI ED	001*, 010, 011, 022	1	
MU195050A	Noise Generator	-	1	
MX183000A-PL001	Jitter Tolerance Test	-	1	
MX183000A-PL021	PCIe Link Training	-	1	Gen1-4
MX183000A-PL025	PCIe Gen5 Link Training Software	-	1	PL021 required to add PL025
J1815A	MP1900A PCIe Measurement Component Set	-	1	
Z2025A	PCIe CBB Controller	-	1	for Add-in-card tests, supports GRL automation software
Z2029A	PCIe 100 MHz Reference Clock Buffer	-	1	for Add-in-card tests
G0430A	PCIe5 Re-Driver Set	-	1	Recommended when System test return path is 18 dB or more

PCI Express Receiver Test Recommended Equipment List (2/2)

Choose the automation software matching your oscilloscope.

Model	Electrical Test	Remark
QPHY-PCIE-Tx-Rx	PCIE Gen3/4/5 Tx, Rx	Teledyne LeCroy scope Purchase from Teledyne LeCroy
GRL-PCIE4-BASE-RXA	PCIE Gen4 Base Rx	Tektronix or Keysight scope Purchase from Granite River Labs
GRL-PCIE4-CEM-RXA	PCIE Gen4 CEM Rx	
GRL-PCIE5-BASE-RXA	PCIE Gen5 Base Rx	
GRL-PCIE5-CEM-RXA	PCIE Gen5 CEM Rx	

Meeting Next-Generation Standards

Next-generation PCIe Gen6 uses PAM4 interfaces. The all-in-one MP1900A with PAM4 PPG module covers PCIe Gen1 to Gen5 compliance tests including Link negotiation, Gen6 PAM4 BER measurements, and JTOL measurements.*

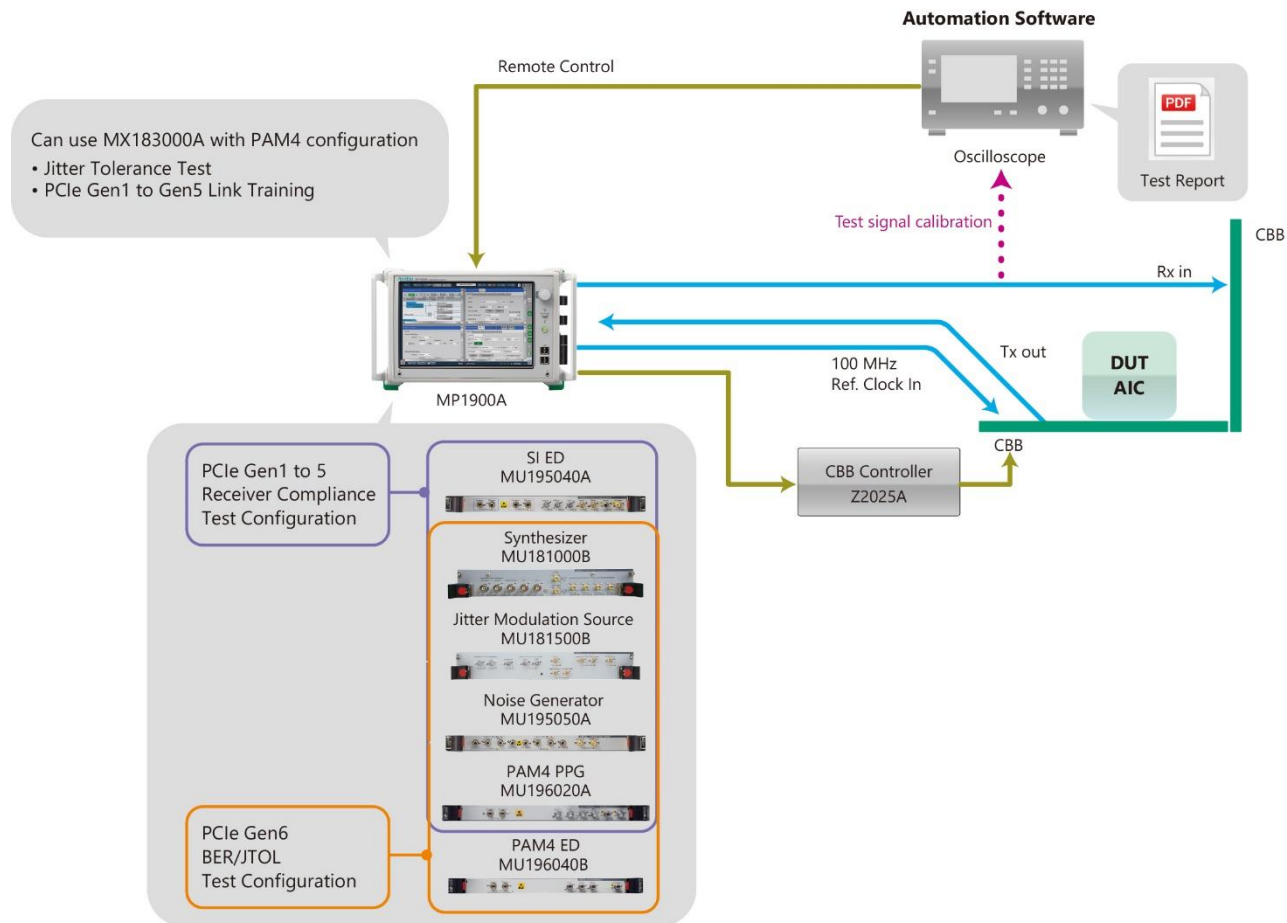

* Contact our business section about Gen6 compliance tests.

PCIe 6.0 Base Spec. Test Solution

- Built-in Presets and Compliance Patterns (MCP/CP) support PCIe 6.0 Base Spec. design inspection requirements
- SKP OS Filter function supports Common/Separate Ref. Clock (SRNS, w/o SSC)
- Real-time measurement of FEC Uncorrectable errors and future planned SW upgrades to PCIe 6.0 FEC
- Automatic stress signal calibration and BER measurement using automation software to cut evaluation time and raise work efficiency

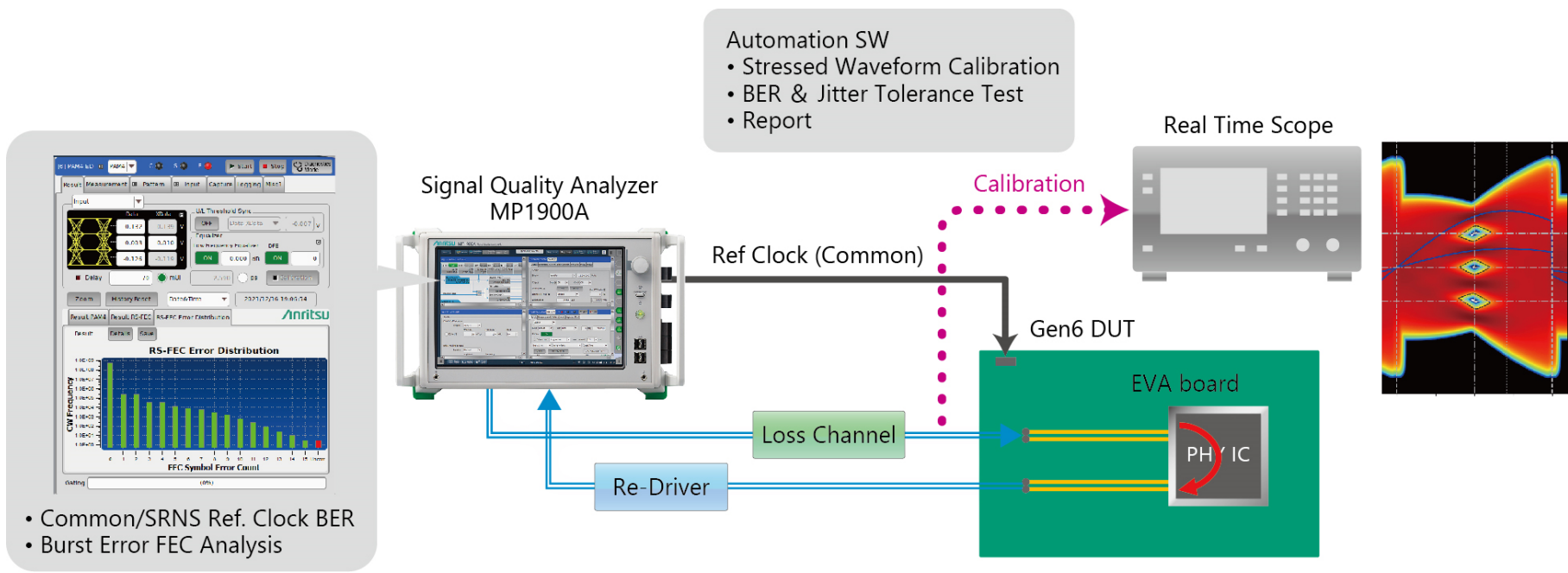

PCIe 6.0 Separate Ref. Clock (SRNS) Support

- Both Common Ref. Clock and Separate Ref. Clock (SRNS, w/o SSC) clock architectures supported by BER measurement
- BER measurement of only valid data at SRNS by filtering DUT insertion SKP signal using ED SKP OS Filter function
- Future planned Separate Ref. Clock (SRIS, w/ SSC) support with HW and SW upgrade

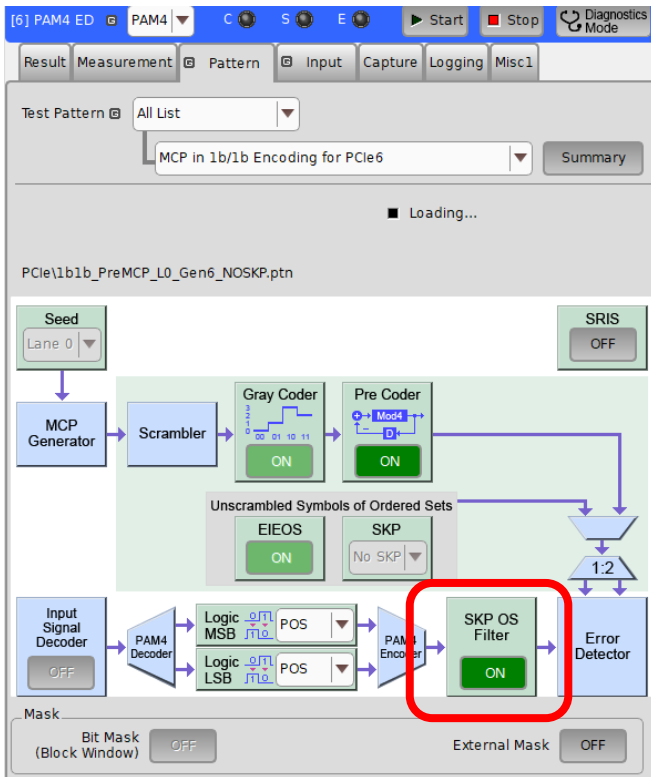

PAM4 ED SKP OS Filter Setting Screen

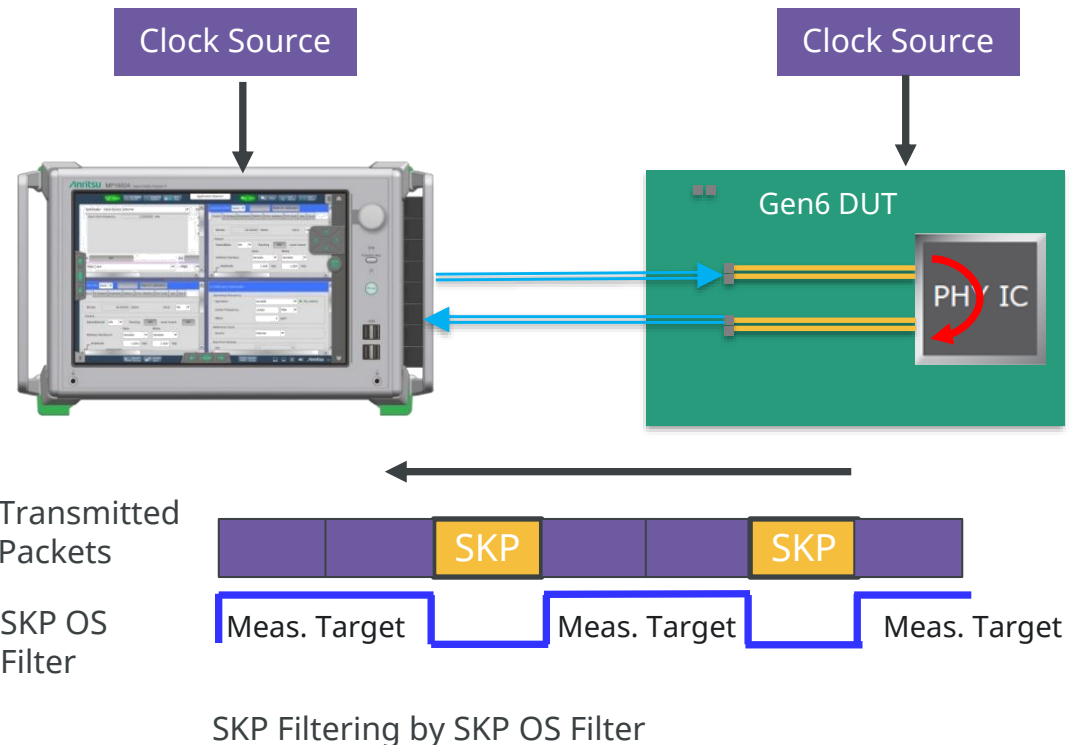

PCIe Gen1 to 6 Receiver Test Recommended Equipment List (1/2)

Model	Name	Option	Qty	Remark
MP1900A	Signal Quality Analyzer-R	-	1	
MU181000B	12.5GHz 4port Synthesizer	002	1	
MU181500B	Jitter Modulation Source	-	1	
MU196020A	PAM4 PPG	001, 011	1	Gen1-6*1
MU195040A	21G/32G bit/s SI ED	001, 010, 011, 022	1	Gen1-5*2
MU196040B	PAM4 ED	001, 011, 022, 041, 042*3	1	Gen6*2
MU195050A	Noise Generator	-	1	
MX183000A-PL001	Jitter Tolerance Test	-	1	
MX183000A-PL021	PCIe Link Training	-	1	Gen1-4
MX183000A-PL025	PCIe Gen5 Link Training Software	-	1	PL021 is required to add PL025

*1: PAM4 PPG also supports PCIe Gen1 to Gen5 Link Negotiation and Compliance tests using the GRL automation software with the MX183000A.

*2: The MU195040A is required for PCIe Gen1 to Gen5 for Compliance test. The MU196040B supports PAM4 signal BER measurements along with Jitter Tolerance measurements.

*3: RS-FEC error real-time measurement option. Enquire about future PCIe 6.0 FEC support.

PCIe Gen1 to 6 Receiver Test Recommended Equipment List (2/2)

Model	Name	Option	Qty	Remark
J1815A	MP1900A PCIe Measurement Component Set	-	1	
Z2025A	PCIe CBB Controller	-	1	for Add-in-card tests, supports GRL automation software
Z2029A	PCIe 100 MHz Reference Clock Buffer	-	1	for Add-in-card tests
G0430A	PCIe5 Re-Driver Set	-	1	Recommended when Gen5 System test return path is 18 dB or more, or Gen6 Base return path is Typ. 3 to 4 dB or more

Choose the automation software matching your oscilloscope.

Model	Electrical Test	Remark
GRL-PCIE4-BASE-RXA	PCIE Gen4 Base Rx	Tektronix or Keysight scope Purchase from Granite River Labs
GRL-PCIE4-CEM-RXA	PCIE Gen4 CEM Rx	
GRL-PCIE5-BASE-RXA	PCIE Gen5 Base Rx	
GRL-PCIE5-CEM-RXA	PCIE Gen5 CEM Rx	
GRL-PCIE6-BASE-RXA	PCIE Gen6 Base Rx	



USB Type-C Test Solution

USB Type-C Receiver Test Solution

- Wideband operation from 2.4 Gbit/s to 21 Gbit/s with expansion to 32.1 Gbit/s without hardware upgrade.

Same configuration supports receiver tests of USB Type-C interfaces (USB 3.2, USB4, Thunderbolt 3, DisplayPort 1.4) .

- Combination with automation software supports oscilloscope from main makers
Simplifies complex test procedures and reduces work burden by using own oscilloscope
- High-performance multichannel BERT with high-quality output waveforms (12-ps Tr/Tf, 115-fs rms Intrinsic Jitter) and high-input sensitivity (15 mV EH)
Supports higher-reproducibility receiver tests

USB Type-C Receiver Test (USB4, Thunderbolt3)

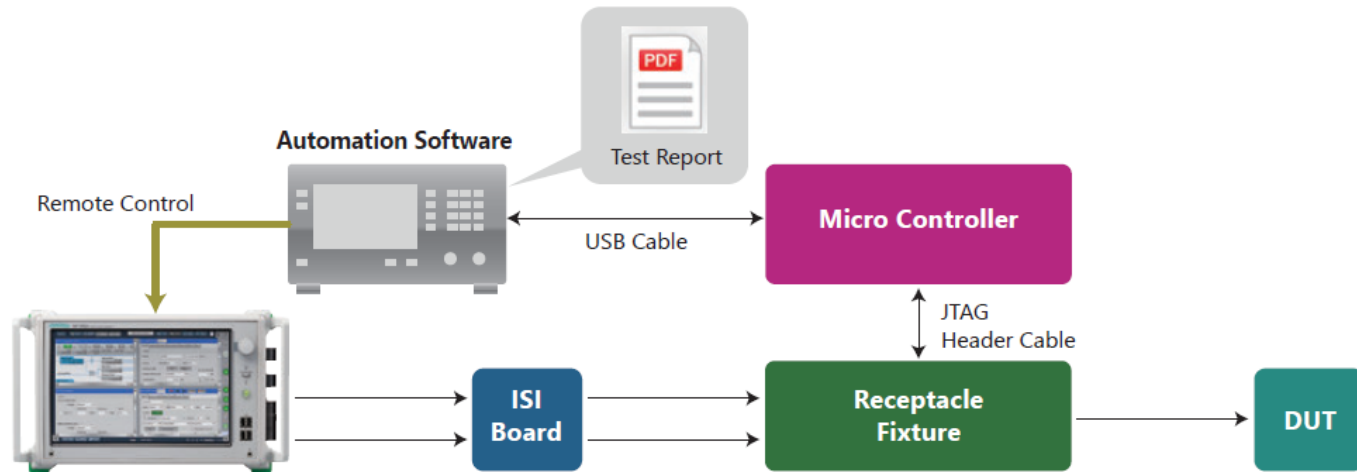

MP1900A Series USB3.2 Receiver Test Solution

- Protocol Aware and All-in-one USB3.2 Rx test solution. Supports USB 3.2 x2.
- Wideband BERT 2.4 Gbit/s to 32.1 Gbit/s supporting PCIe Gen4/5 and Thunderbolt3
- High-quality waveforms with low Intrinsic Jitter, high-reproducibility measurement using high-sensitivity ED
- Link Training and LTSSM analysis function
- Transmit and receive LFPS and LBPM signals
- Insert and identify SKP Ordered Set
- Jitter Addition (SJ, RJ, BUJ, SSC) and Tolerance measurement

USB Receiver Test Solution

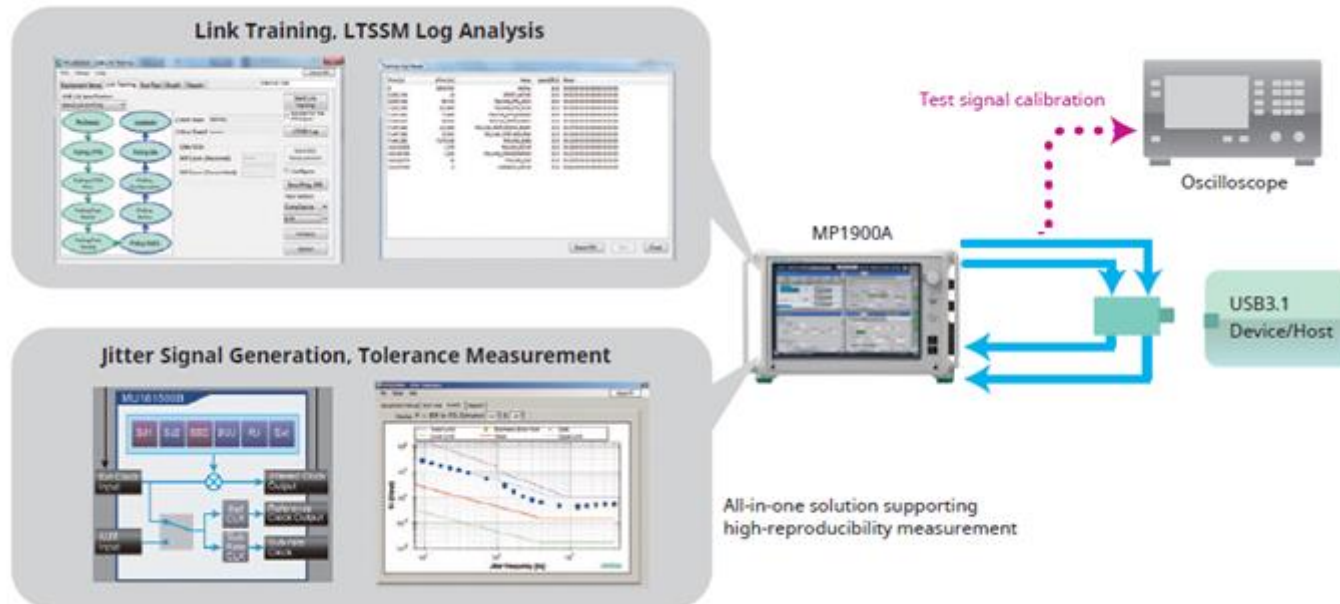

Shorter Development Period by LTSSM Analysis Function for Troubleshooting Cause of Link Faults

Controls state transition from "Detect" to "Loopback" required by Rx test

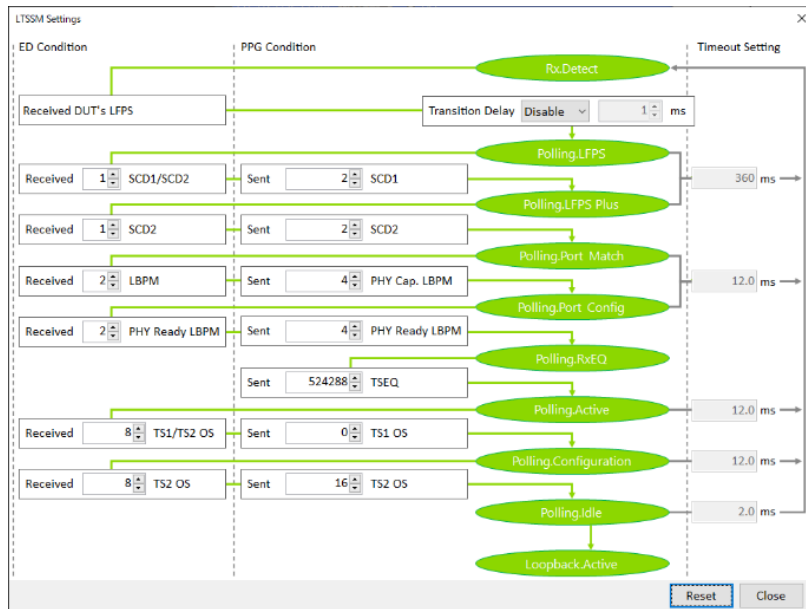

For confirming results of each state transition with Training Log Viewer

Time [ns]	ΔTime [ns]	State	Speed[Gt/s]	Detail
0	6,945,704	INITIAL	10.0	00 00 00 00 00 00 00 00 00 00
6,945,704	24	DETECT_ACTIVE	10.0	00 02 00 00 00 00 00 00 00 00
6,945,728	69,440	POLLING_LFPS_SCD1	10.0	00 12 00 00 00 00 00 00 00 00
7,015,168	121,864	POLLING_LFPS_PLUS	10.0	00 14 00 00 00 00 00 00 00 00
7,137,032	71,808	POLLING_LFPS_ENDSCD	10.0	00 15 00 00 00 00 00 00 00 00
7,208,840	89,048	POLLING_PORT_MATCH	10.0	00 16 00 00 00 00 00 00 00 00
7,297,888	110,080	POLLING_PORT_CONFIG_READY	10.0	00 17 00 00 00 00 00 00 00 00
7,407,968	26,392	POLLING_PORT_ENDLBPM	10.0	00 18 00 00 00 00 00 00 00 00
7,434,360	7,178,248	POLLING_RXEQ	10.0	00 1A 00 00 00 00 00 00 00 00
14,612,608	2,176	POLLING_ACTIVE	10.0	00 1B 00 00 00 00 00 00 00 00
14,614,784	2,192	POLLING_CONFIGURATION	10.0	00 1C 00 00 00 00 00 00 00 00
14,616,976	24	POLLING_IDLE	10.0	00 1D 00 00 00 00 00 00 00 00
14,617,000	0	LOOPBACK_ACTIVE	10.0	00 64 00 00 00 00 00 00 00 00

Buttons: Export CSV, Stop, Close

USB 3.2 Retimer Rx Test Support

- Supports Rx Test for all new USB 3.2 Retimer DUT types (BLR/SRIS, Embedded/Component)
- Easy expandability from earlier Host/Device test configurations
- High-performance BERT with expandability up to 32.1 Gbit/s from wide 2.4 to 21 Gbit/s range without changing HW to cover USB4 Gen3, Thunderbolt 3/4, PCIe 5.0

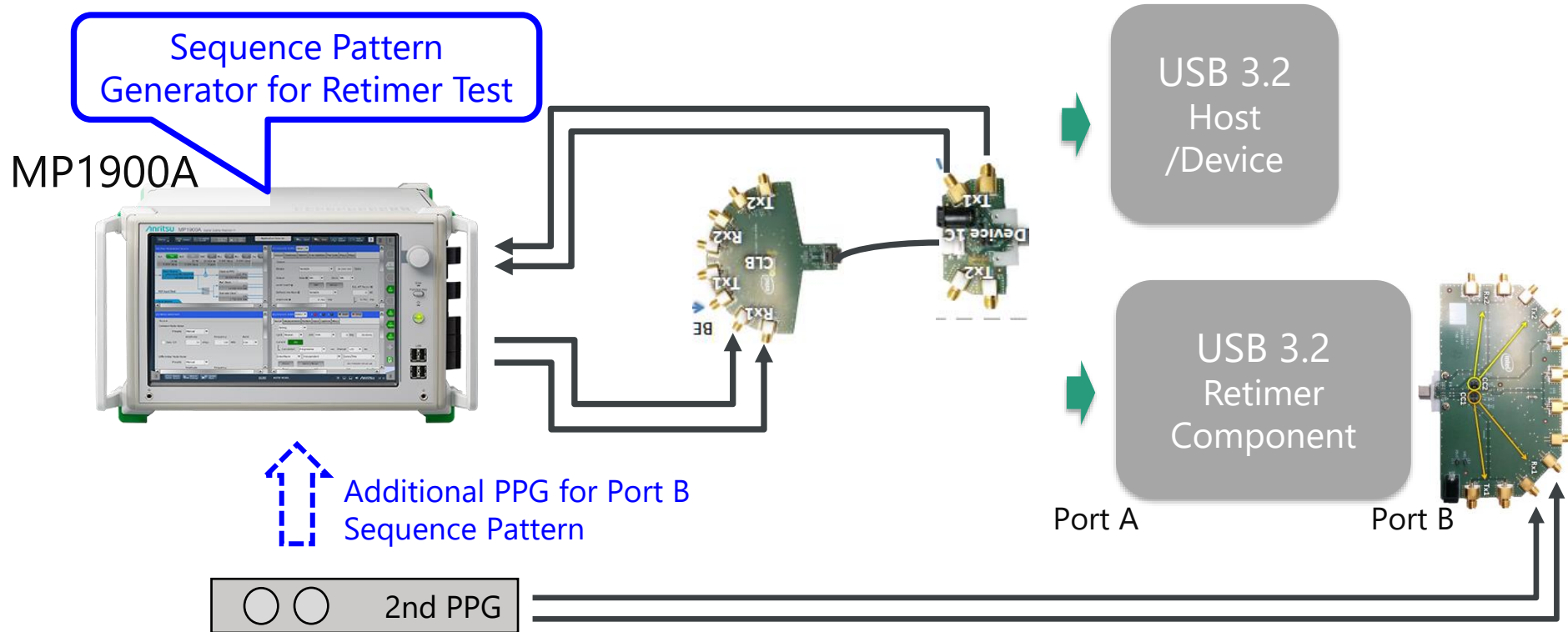

USB Type-C Receiver Test Recommended Equipment List (1/2)

Model	Name	Option	Qty	Remark
MP1900A	Signal Quality Analyzer-R	-	1	
MU181000B	12.5GHz 4port Synthesizer	-	1	
MU181500B	Jitter Modulation Source	-	1	
MU195020A	21G/32G bit/s SI PPG	010, 011	1	
		020, 021,031	(1)	Required for USB3.2x2
MU195040A*	21G/32G bit/s SI ED	010, 011, 022	1	
		020, 021, 022	(1)	Required for USB3.2x2
MU195050A	Noise Generator	-	1	
MX183000A-PL001*	Jitter Tolerance Test	-	1	
MX183000A-PL022*	USB Link Training	-	1	
MX183000A-PL023*	USB 3.2 x 2 Link Training		1	Supports USB 3.2 x2 Also requires MX183000A-PL022
J1551A	Coaxial Skew Matched Cable (0.8 m)	-	3	
K261	DC Block	-	2	
-	K-SMP Adapter	-	4	Recommend part equivalent to Rosenberger 02K119-K00E3
-	ISI Channel	-	1	Recommend part equivalent to Tektronix BSA12500
-	USB4/TBT3 Test Fixture	-	1	Purchase from Wilder Technology
USB31CET*	USB3.1 Type-C Test Fixture	-	1	Purchase from USB-IF website

*These items are required only for USB3.2 test. USB4 and TBT3 don't need them.

USB Type-C Receiver Test Recommended Equipment List (2/2)

Choose the automation software matching your oscilloscope.

Model	Electrical Test	Remark
QPHY-USB4-TX-RX	USB4/TBT3 Tx, Rx	Teledyne LeCroy scope Purchase from Teledyne LeCroy
QPHY-USB3.1-Tx-Rx	USB 3.2 Tx, Rx	
GRL-USB4-RXA	USB4 Rx	Keysight scope Purchase from Granite River Labs
GRL-TBT3-RXA	TBT3 Rx	
GRL-USB31-RXA	USB 3.2 Rx	
GRL-USB32-RXA	USB 3.2 x2 Rx	



SAS Test Solution

SAS Receiver Test Solution

- Same configuration supports receiver tests of SAS and PCIe.
Wideband operation from 2.4 Gbit/s to 21 Gbit/s with expansion to 32.1 Gbit/s
Supports SAS-4 (22.5 Gbit/s) and Gen5 (32G) measurements without changing configuration
- Combination with automation software supports oscilloscope from main makers
Simplifies complex test procedures and reduces work burden by using own oscilloscope.
- High-performance multichannel BERT with high-quality output waveforms (12-ps Tr/Tf, 115-fs rms Intrinsic Jitter) and high-input sensitivity (15 mV EH)
Supports higher-reproducibility receiver tests

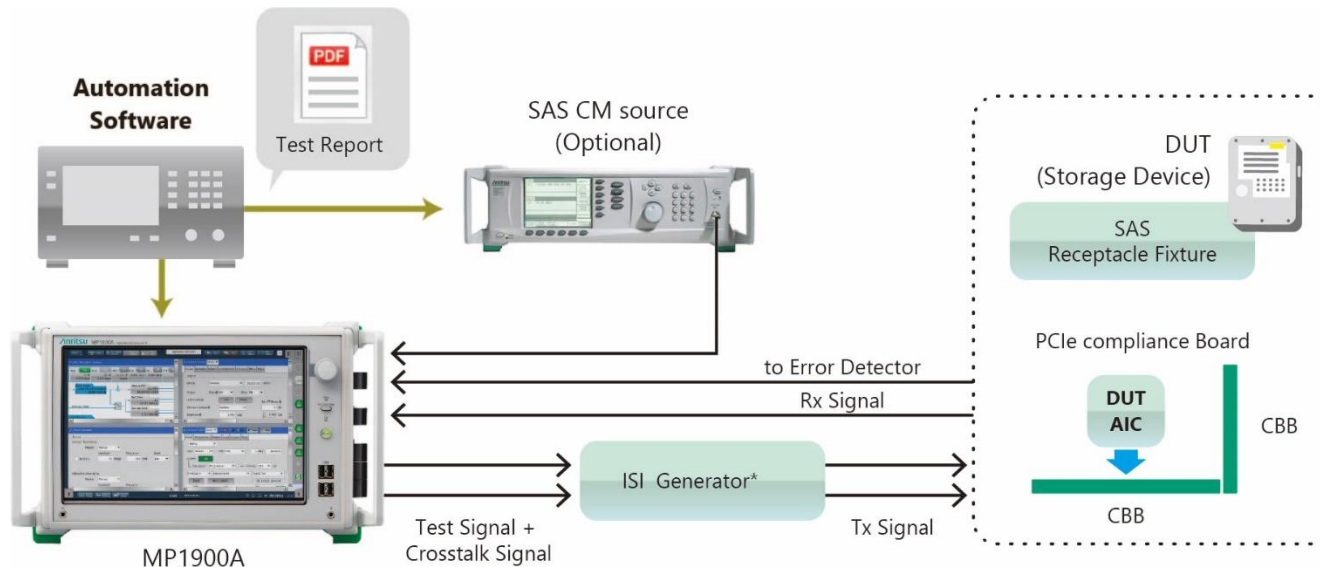

* Should use specified ISI generator by PCIe or SAS

SAS Receiver Test Recommended Equipment List (1/2)

Model	Name	Option	Qty	Remark
MP1900A	Signal Quality Analyzer-R	-	1	
MU181000B	12.5GHz 4port Synthesizer		1	
MU181500B	Jitter Modulation Source	-	1	
MU195020A	21G/32G bit/s SI PPG	001*, 010, 011, 040	1	*Add Opt-001 for expansion to SAS-4
MU195050A	Noise Generator	-	1	
MU195040A	21G/32G bit/s SI ED	001*, 010, 011, 022	1	*Add Opt-001 for expansion to SAS-4
J1758A	Variable ISI Channel	-	1	
-	Mated Adapter Fixture Pair	-	1	
K261	DC block	-	2	
MG3692C	2GHz to 20GHz Signal Generator	-	1	for CM tests
K241C	RF Splitter	-	1	

Requires cables to connect with other equipment

SAS Receiver Test Recommended Equipment List (2/2)

Choose the automation software matching your oscilloscope.

Model	Measurement item	Remark
GRL-SAS3-RXA	SAS3 Receiver Calibration and Test	Tektronix or Keysight scope Purchase from Granite River Labs
GRL-SAS4-RXA	SAS4 Receiver Calibration and Test	
GRL-SAS34-RXA	SAS4 and SAS3 Receiver Calibration and Test	



DisplayPort Test Solution

DisplayPort Receiver Test Solution

- Wideband operation from 2.4 Gbit/s^{*1} to 21 Gbit/s with expansion to 32.1 Gbit/s without hardware upgrade

Flexible support for DisplayPort2.0 (20 Gbit/s) and future faster speeds

(*1: Can only generate special RBR (1.62 Gbit/s) pattern)

- All-in one Dual-Channel PPG
True crosstalk effects can be analyzed by controlling inter-channel skew.
- Combination with automation software supports oscilloscope from main makers
Simplifies complex test procedures and reduces work burden by using own oscilloscope
- High-quality output waveforms (12-ps Tr/Tf, 115-fs rms Intrinsic Jitter) PPG
Supports higher-reproducibility receiver tests.

DP1.4 SINK Receiver Test

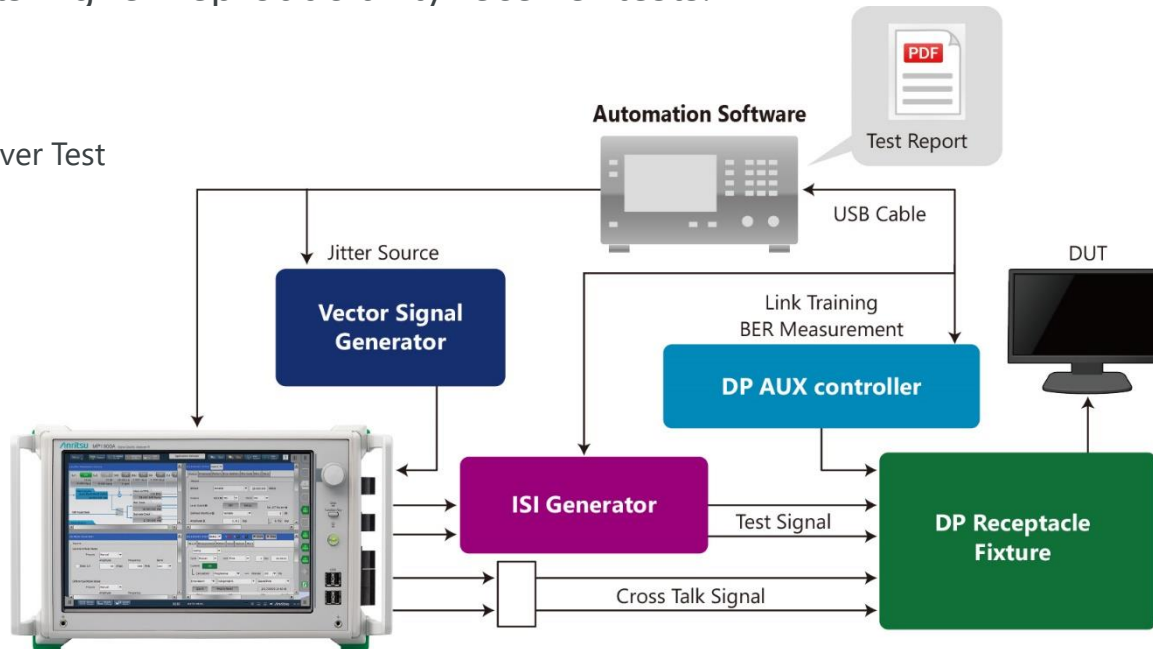

DisplayPort Receiver Test Recommended Equipment List (1/2)

Model	Name	Option	Qty	Remark
MP1900A	Signal Quality Analyzer-R	-	1	
MU181000B	12.5GHz 4port Synthesizer	-	1	
MU181500B	Jitter Modulation Source	-	1	
MU195020A	21G/32G bit/s SI PPG	020, 021	1	
MU195050A	Noise Generator	-	1	
-	Vector Signal Generator	-	1	Recommend Regol DSG815
-	ISI Generator	-	1	Recommend Artek CLE1000-A2
-	DisplayPort AUX Controller	-	1	Recommend Unigraf DPT-200
-	VESA-Approved DisplayPort Mated Adapter Fixture Pair	-	1	Recommend Wilder Technology DP-TPA-P DP-TPA-R
-	DC Block	-	2	Recommend Weinchel Aeroflex Model 7006-1 20 GHz
-	÷4 RF Splitter	-	2	Recommend Anritsu AN44182A
-	TTC (Transition Time Converter)	-	2	Recommend HYPERLABS Model # HL9450-60
-		-	2	Recommend HYPERLABS Model # HL9450-150

Requires cables to connect with other equipment

DisplayPort Receiver Test Recommended Equipment List (1/2)

Model	Measurement item	Remark
GRL-DP14-SINKAN	DisplayPort1.4 SINK	Tektronix or Keysight scope Purchase from Granite River Labs



MP1900A PAM4 Applications

Outline of MP1900A Series PAM4 BERT

- Supports bit error rate measurements optimized for high-speed 400 GbE and next-generation 800 GbE interfaces
- High-quality data output waveforms up to 64 Gbaud and high input sensitivity performance provide strong support for testing PAM4 device designs
- All-in-one Jitter Addition, Clock Recovery, Emphasis, NRZ/PAM3/PAM4 Pattern Editing, SER functions, etc.
- Easily configured, high-reproducibility PAM4 measurement solution

MP1900A PAM4 Target Applications

200/400/800 GbE, CEI-56G/112G, InfiniBand HDR, 64G Fibre Channel

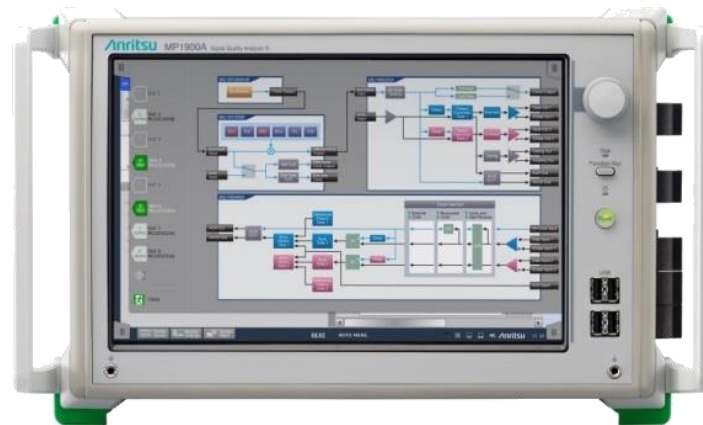

MP1900A PAM4 BERT Features

- All-in-one, high-reproducibility, easily configured test solution
- High-quality waveforms for more accurate measurement
- Easy, low-cost, future-proof expandability supporting high bit rates and multichannels

PAM4 One Box Test Solution

Emphasis 4Tap, 20dB

Built-in Clock Recovery



Jitter/Noise Addition

Jitter Tolerance Test

Highest Level Waveform Quality

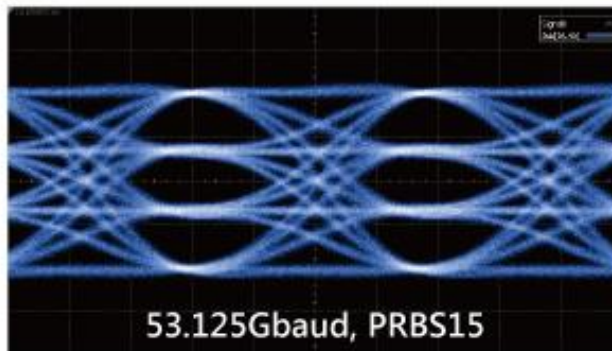

Next-Generation Terabit

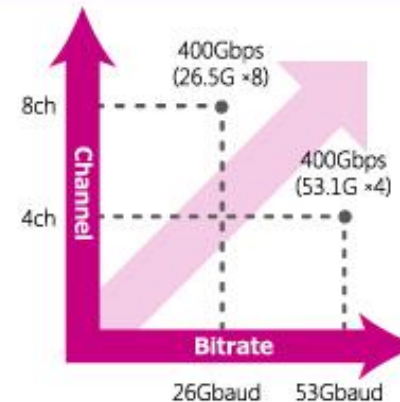

PAM4 All-in-One BERT Solution

Easy-to-use and configure all-in-one solution with high reproducibility, helping cut test times

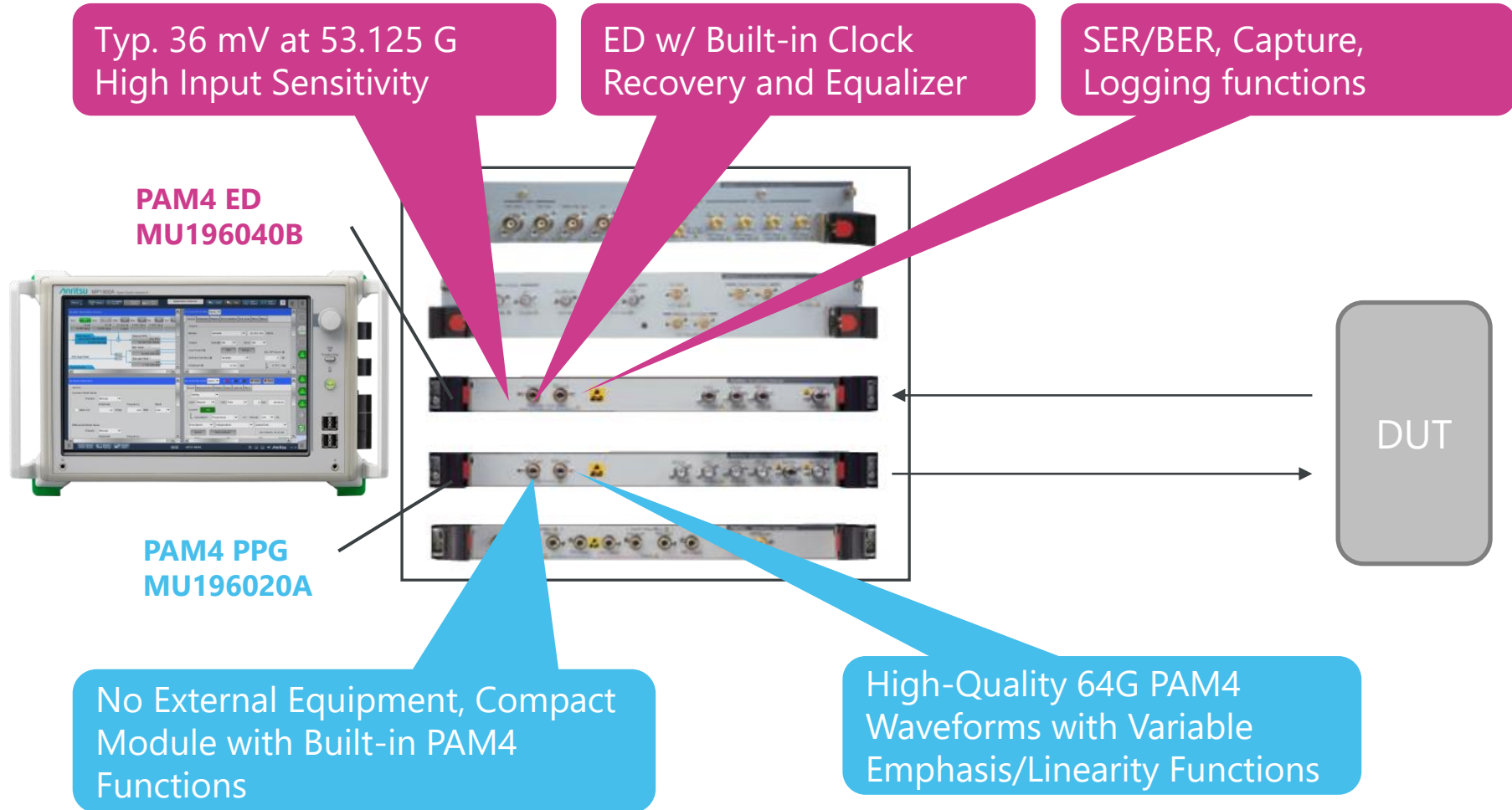

High-Quality Waveform PAM4 PPG MU196020A

Best-in-class waveform quality with low Intrinsic Jitter (typ. 170 fs (rms)) and fast Tr/Tf (typ. 8.5 ps) for more accurate evaluation of actual DUT performance

64.2 Gbaud

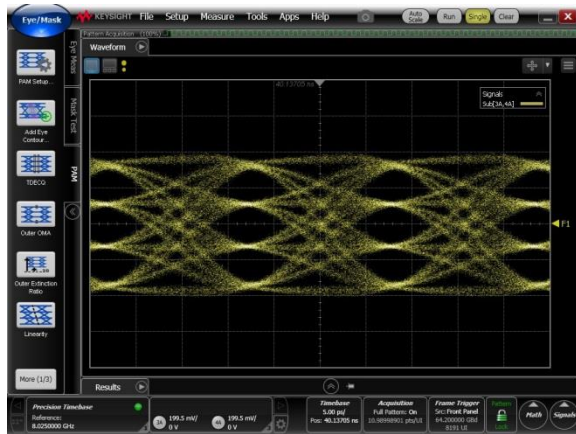

53.125 Gbaud

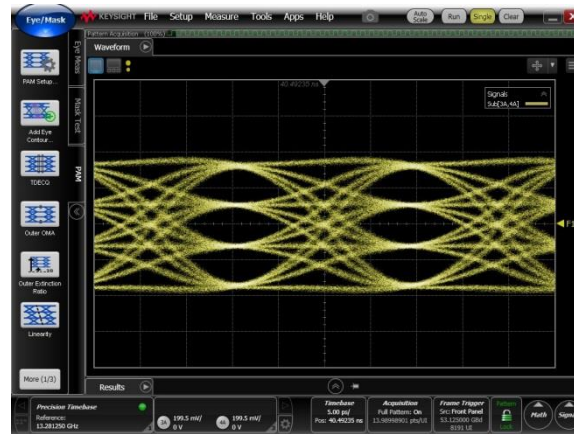

26.5625 Gbaud

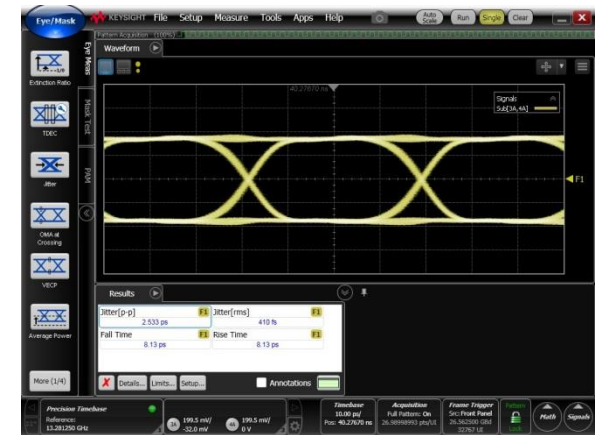
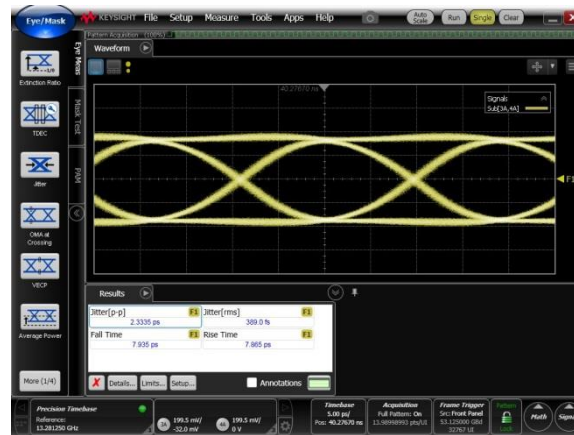
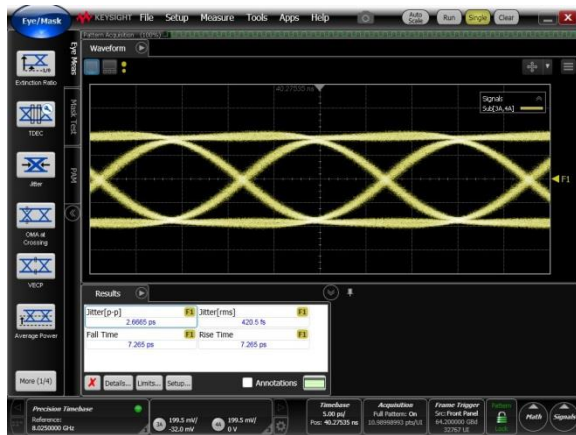
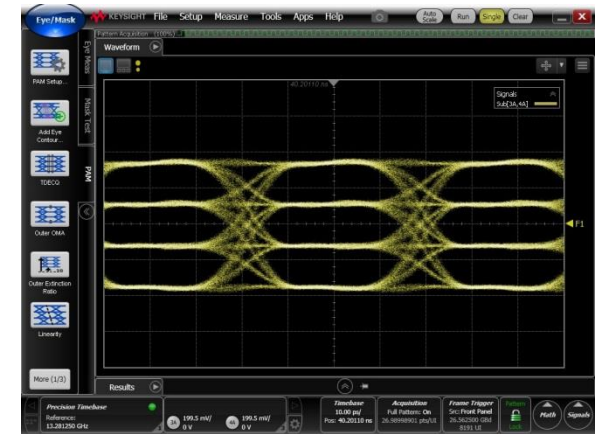

Differential 1.4 Vp-p, PRBS13Q pattern, J1789A 40-cm cable + 70 GHz Scope

116 Gbit/s PAM4 Best Level High-Sensitivity Input Performance

High sensitivity input of 36 mV (typical at 53.125 Gbaud) simplifies previously difficult PAM4 error troubleshooting measurements.

Error-Free at 53.125 Gbaud
Best level PAM4 sensitivity

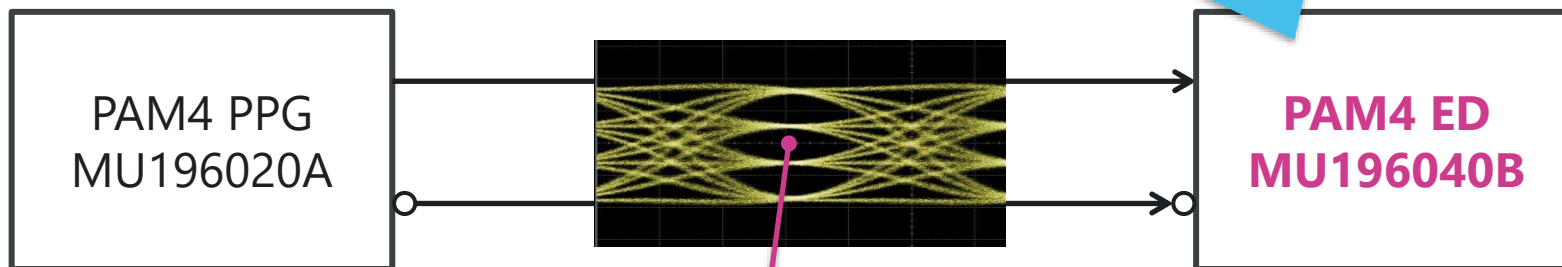

Typ. 36 mV EH/ Eye

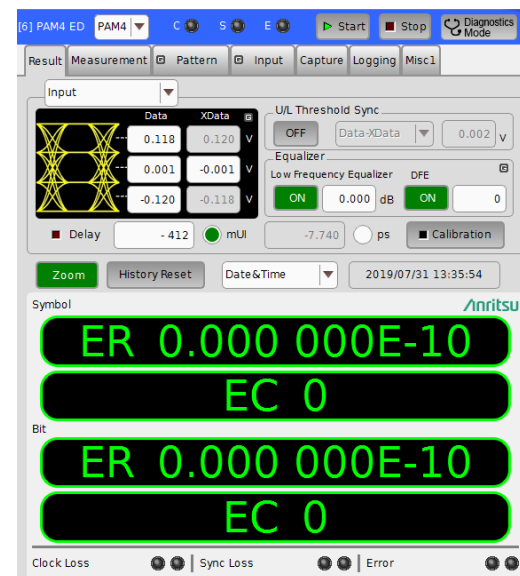

Multichannel Support and Expandability (1/2)

One MP1900A PPG supports up to 4ch for 400 GbE (53 Gbaud x 4 Lanes), and faster evaluations, helping cut future support upgrade costs.

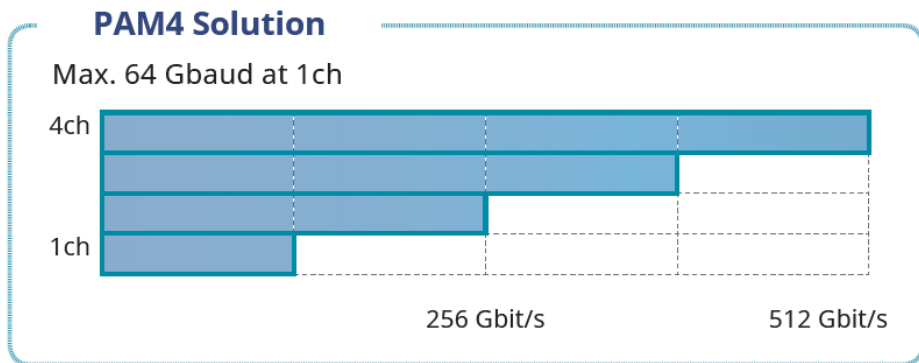

• Channel Synchronization

One MP1900A unit supports synchronous output for up to 4ch; two units support up to 8ch.

*Future support for 8ch

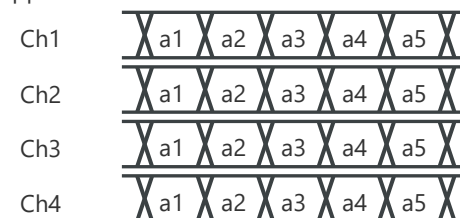

• 2ch Combination (NRZ)

Supports shift to "a1b1 a2b2 . . ." pattern

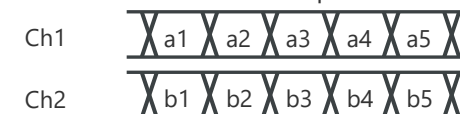

• 4-Lane DUT (Driver + E/O) Measurement Example

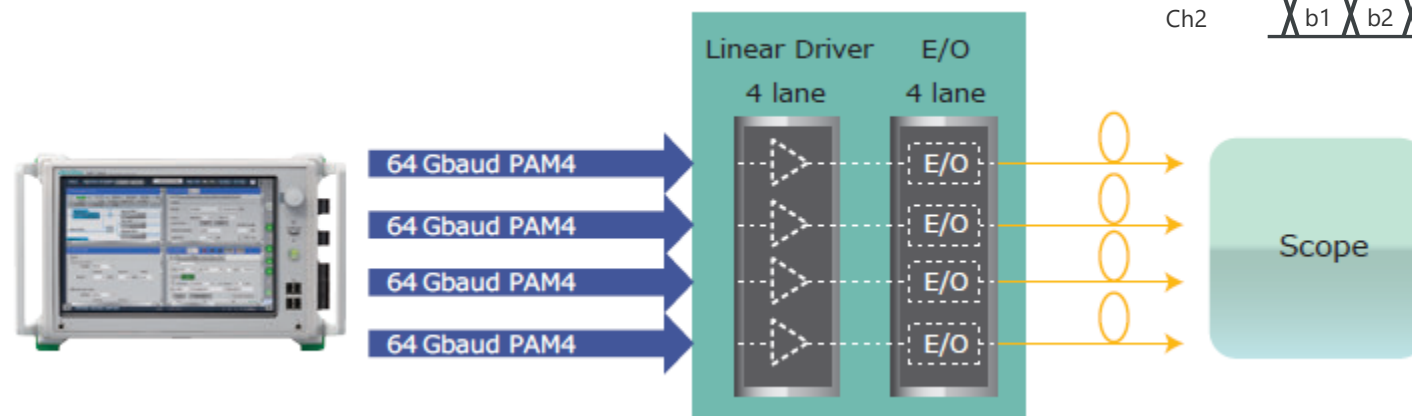

Multichannel Support and Expandability (2/2)

Expanded support for 800G using 8ch synchronization function
(4ch x 53.125 Gbaud PAM4 x two MP1900A units)

Supports QSFP-DD transceiver FEC evaluation using 8-lane FEC Pattern
Generation function

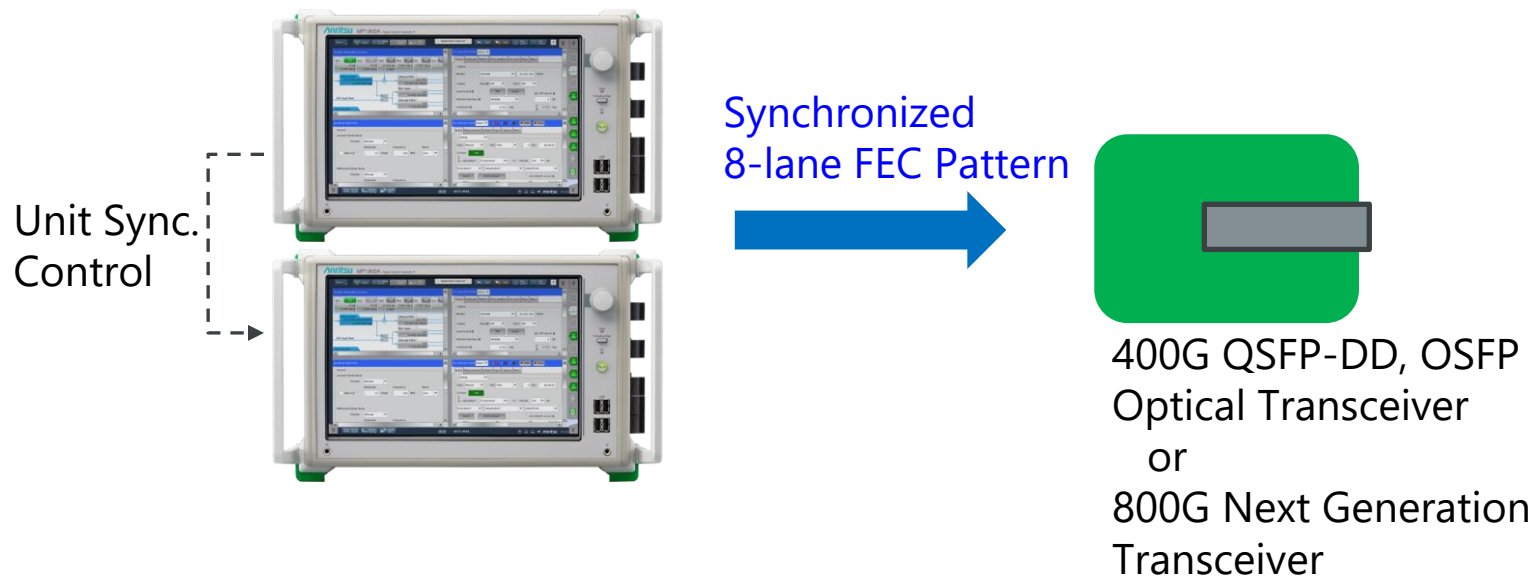

Jitter Tolerance Measurement Function

Supports PAM4 Jitter Tolerance test using just one unit. A measurement system to help cut measurement time is configured easily by combining the Jitter/Noise Addition function, built-in Clock Recovery function, and Jitter Tolerance MX183000A-PL001 software.

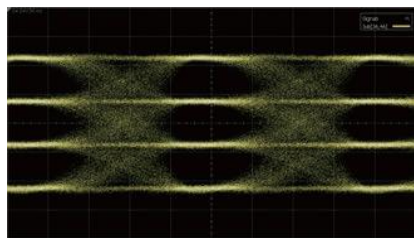
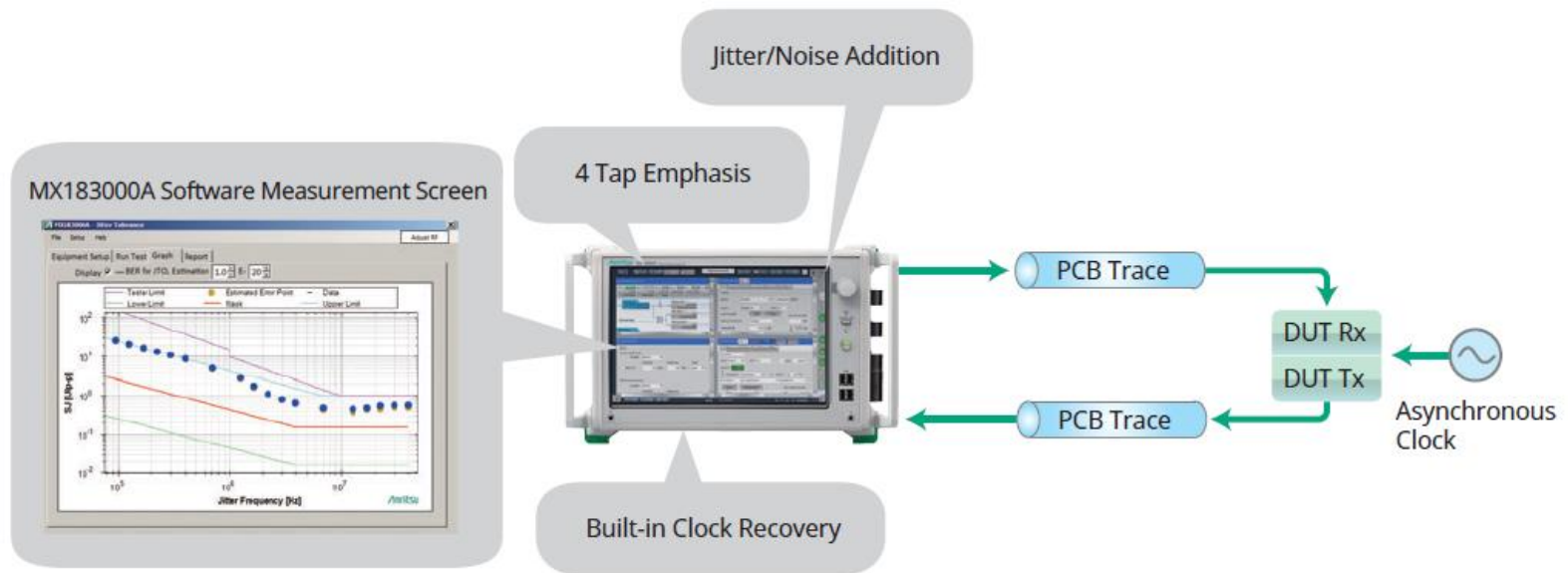

Sine-Wave Jitter (SJ)

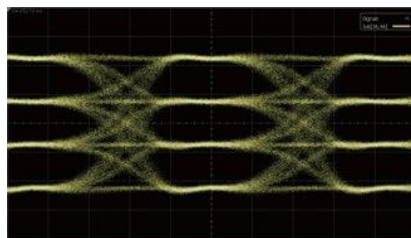

Random Jitter (RJ)

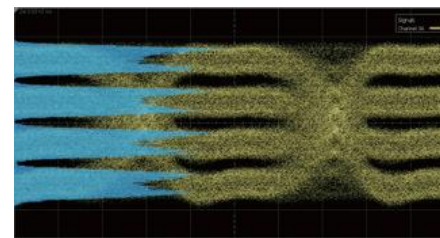

CM/DM Noise

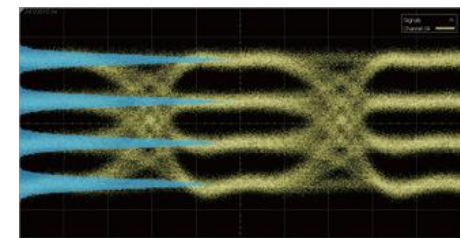

White Noise

Jitter Tolerance Measurement using DUT BER Counter

When the DUT has a built-in bit error counter, combination with the MP1900A PPG makes it easy to configure a highly cost-effective Jitter Tolerance measurement environment.

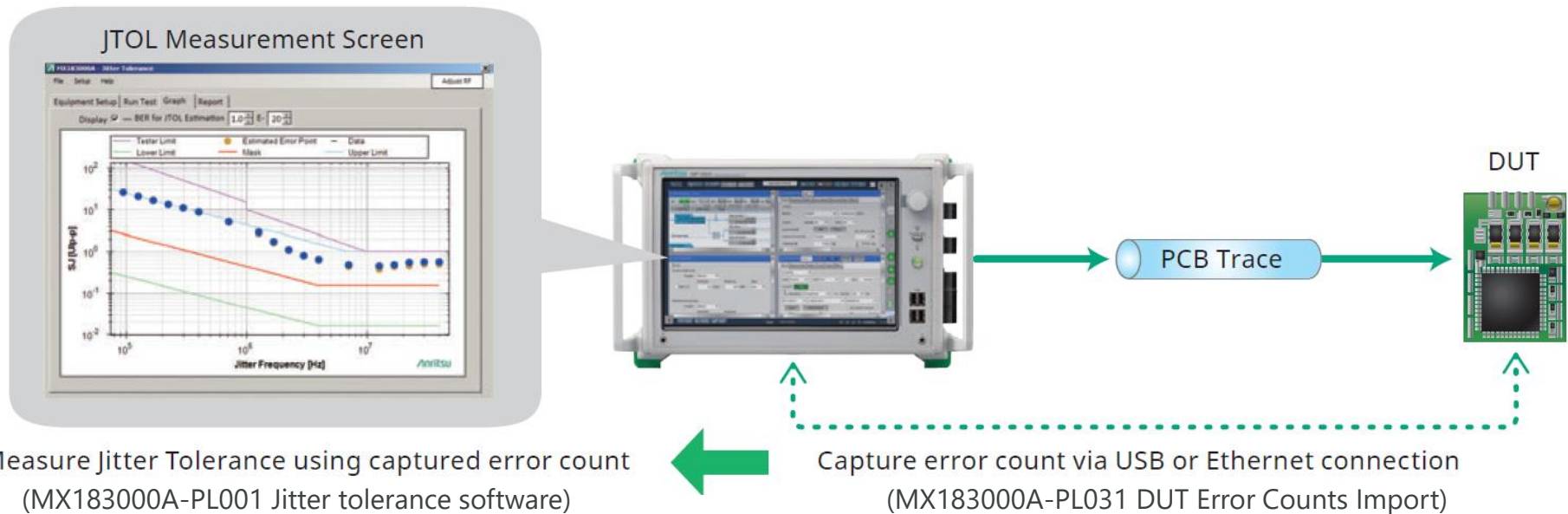

Multilane FEC Evaluation

FEC can be evaluated by combining FEC pattern generation with error insertion, and reading the DUT bit error count.

Evaluating Optical FEC Signal Transmission

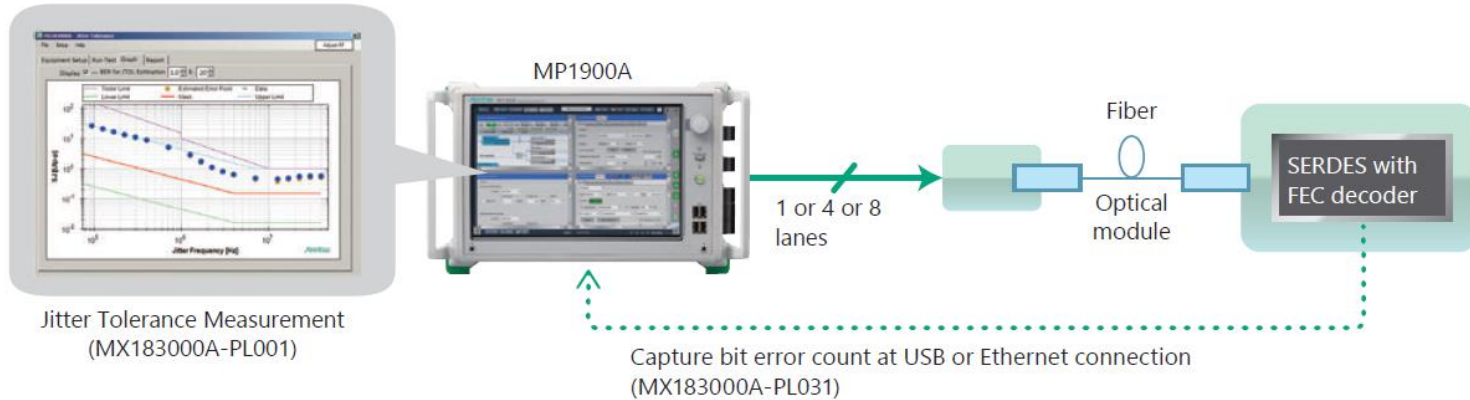

Evaluating Electrical FEC Signal Transmission

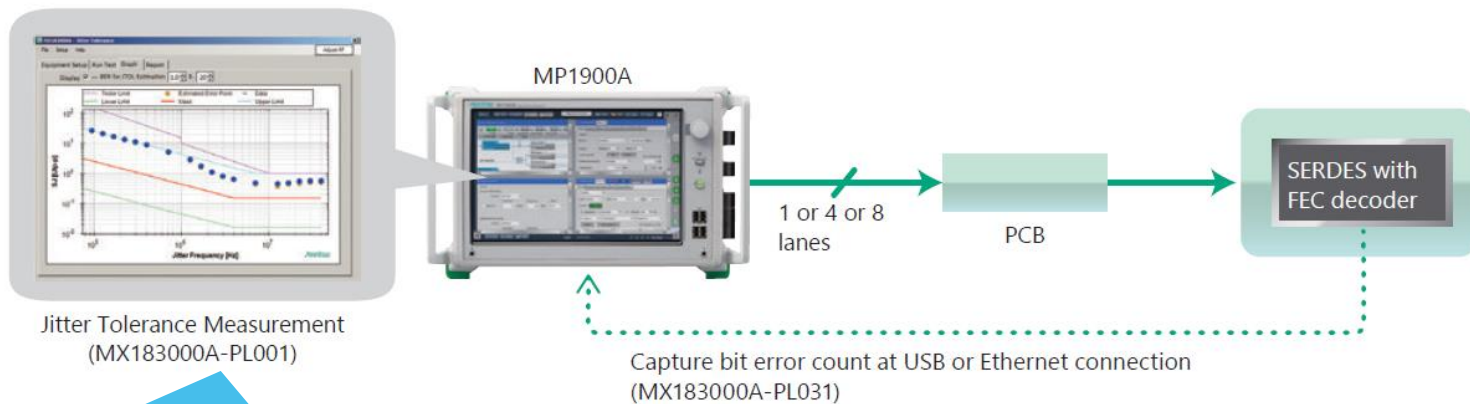

Evaluate Jitter Tolerance, etc., using captured error count

PAM4 PPG/ED Specifications

PAM4 PPG MU196020A

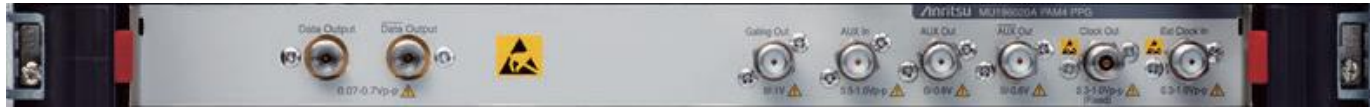

- Baud-rate: 2.4 Gbaud to 32.1/58.2/64.2 Gbaud
- Output amplitude: 0.14 Vp-p to 1.6 Vp-p (Differential)
- Emphasis: 4Tap, ± 20 dB (1 post/2 pre-cursor), ISI/Channel Emulator
- Intrinsic jitter(rms): 170 fs (typ., NRZ)
- Tr/Tf (20-80%): 8.5 ps (typ., NRZ)
- Multichannel synchronization
- FEC pattern generation

PAM4 ED MU196040B



- Baud-rate: 2.4 Gbaud to 32.1/58.2 Gbaud PAM4 and 64.2 Gbaud NRZ
- Input amplitude (max.): 1.0 Vp-p (NRZ, PAM4)
- Input sensitivity(Eye Height) : 23 mV (typ., 26.5625 Gbaud), 36 mV (typ., 53.125 Gbaud)
- Built-in Clock Recovery: 2.4 G to 29 Gbaud or 32.1 Gbaud/ 51 G to 58.2 Gbaud extension
- Analog bandwidth: >40 GHz (nominal)
- Built-in Equalizer: Low Frequency Equalizer(2 dB)+DFE(1.4 dB)
- SER measurement, logic error analysis using Diagnostics Mode, Capture , Logging function

Typical Configuration of 58 Gbaud PPG/ED

Model	Name	Option	Qty	Remark
MP1900A	Signal Quality Analyzer-R	-	1	
MU181000B	12.5GHz 4 port Synthesizer	-	1	
MU181500B	Jitter Modulation Source	-	1	For jitter injection
MU196020A	PAM4 PPG	002, 011, 040, 042	1	
MU196040B	PAM4 ED	002, 011, 021, 023, 041	1	

Software for jitter tolerance test

Model	Name
MX183000A-PL001	Jitter Tolerance Test
MX183000A-PL031	DUT Error Counts Import

Optional parts

Model	Name
J1789A	Electrical Length Specified cable (0.4m, V connector)
J1790A	Electrical Length Specified cable (0.8m, V connector)
J1800A	ISI Board V
J1793A	Pick OFF Tee (V)

Appendix



Ordering Information

Model	Name
MP1900A	Signal Quality Analyzer-R
MU181000B	12.5GHz 4port Synthesizer
MU181000B-002	SSC Extension
MU181500B	Jitter Generation Source
MU195020A	21G/32G bit/s PPG
MU195020A-001	32Gbit/s Extension
MU195020A-010	1ch Data Output
MU195020A-020	2ch Data Output
MU195020A-011	1ch 10Tap Emphasis
MU195020A-021	2ch 10Tap Emphasis
MU195020A-030	1ch Data Delay
MU195020A-031	2ch Data Delay
MU195020A-040	1ch Variable ISI
MU195020A-041	2ch Variable ISI
MU195020A-050*1	Sequence Editor Function
MU195020A-051*1	Sequence Editor Function PCIe 5 Extension
MU195040A	21G/32G bit/s SI ED
MU195040A-001	32Gbit/s Extension
MU195040A-010	1ch ED
MU195040A-020	2ch ED
MU195040A-011	1ch CTLE
MU195040A-021	2ch CTLE
MU195040A-022	Clock Recovery

Model	Name
MU195050A	Noise Generator
MU195050A-001	White Noise
MU183020A	28G/32G bit/s PPG
MU183040B	28G/32G bit/s High Sensitivity ED
MX183000A-PL001	Jitter Tolerance Test
MX183000A-PL011	PCIe Link Sequence
MX183000A-PL021	PCIe Link Training*2
MX183000A-PL025	PCIe 5 Link Training*2
MX183000A-PL022	USB Link Training*3
MX183000A-PL023	USB 3.2 x 2 Link Training*3
MX183000A-PL031	DUT Error Counts Import

1: Opt-050 supports PCIe Gen1 to Gen 4, and

USB 3.2 x1. Opt-051 supports PCIe Gen5.

Opt-050 is required when adding Opt-051.

*2: The PL021 option supports PCIe Gen1 to Gen4.

The PL025 option supports PCIe Gen5.

PL021 is required to add PL025.

*3: PL022 supports USB 3.2 x1.

PL023 supports USB 3.2 x2.

PL022 is required to add PL023.

• Signal Quality Analyzer-R MP1900A

Item	Specification
LCD	12.1" WXGA 1280 x 800
Remote interface	GPIO, LAN
Module slots	8
External equipment interface	USB x6, VGA x1, HDMI x1
OS	Windows 10 IoT Enterprise
Power supply	100 V(ac) to 120 V(ac)/200 V(ac) to 240 V(ac) 50 Hz to 60 Hz
Power consumption	1350 VA max.
Size and mass	340 (W) x 222.5 (H) x 451 (D) mm 20 kg max. (excluding modules)

• 21G/32G bit/s SI ED MU195040A

Item	Specification
Operation bit rate	2.4 Gbit/s to 21 Gbit/s or 32.1 Gbit/s
Number of channels	1 or 2
Input attitude	0.05 Vp-p to 1.0 Vp-p (Single-End) 0.1 Vp-p to 2.0 Vp-p (Differential)
Input sensitivity	15 mV (Eye Height 28.1 Gbit/s)
CTLE	Peak Frequency 14, 8, 4 GHz Gain 0 to -12 dB
Clock Recovery	Yes, supports SSC input
PCIe/USB Link Training	Supported (MX183000A-PL021(PCIe), MX183000A-PL022(USB))
I/O connectors	K (f)

• 21G/32G bit/s SI PPG MU195020A

Item	Specification
Operation bit rate	2.4 Gbit/s to 21 Gbit/s or 32.1 Gbit/s
Number of channels	1 or 2
Output amplitude	0.1 Vp-p to 1.3 Vp-p (Single-end) 0.2 Vp-p to 2.6 Vp-p (Differential)
Emphasis	10Tap
Variable ISI	ISI and Channel Emulation functions
Tr/Tf (20% to 80%)	12 ps (typ.)
Random jitter	115 fs rms (typ.)
PCIe/USB Link Training	Supported (MX183000A-PL021(PCIe), PL025(PCIe 5), PL022(USB))
I/O connectors	K (f)

• Noise Generator MU195050A

Item	Specification
Number of channels	2
Insertion loss	-3 dB
CMI	0.1 GHz to 1 GHz/1 GHz to 6 GHz
DML	2 GHz to 10 GHz
White Noise	10 MHz to 10 GHz
Crest Factor	>5

